



**ABUS**

Security Tech Germany



**MOBILE SECURITY**

**CATALOGUE**

**2026**

# PICTOGRAMS



New product



New colour

## LOCKS



Double locking



Individual Code



Lightweight



Waterproofed lockbody



Pocketsize



SmartX



Alarm



One Key Option



XL size



Rechargeable



Fingerprint



Automatic locking



Battery



OEM



Robust webbing



XPlus



All mounting

## HELMETS



Zoom™ Spin adjustment system



Push-in buckle



Height-adjustable visor



Bug Mesh



Zoom™ Slide adjustment system



Magnetic buckle



Ponytail Fit



Forced Air Cooling



Zoom™ Rapid Fit adjustment system



Snap buckle



Front Eyewear Port / Goggle Fit



Weather protection



Flap Divider™



Double-D buckle



Rear Eyewear Port



Rear Light



Trivider™



Full ring



Collarbone Protection



Front Light



Stitched straps



Half ring



Reflector Sticker



Brake Light



Glow Straps



Ventilation openings



Removable Chinguard



Indicator Light



Flow Straps™



Magnetic height-adjustable visor



Speed Latch System™



Flow Straps™ Pro



Magnetic visor



Ambient Sound Channels (ASC)

# CONTENT



ABUS - Made in Germany .....	004
Approvals .....	005
ONE KEY .....	006
Key Service .....	010
Lock Selector .....	012
U-Shackle locks .....	014
Folding locks .....	026
Chain locks .....	044
Goose Lock .....	068
Steel-O-Flex locks .....	072
Coil cable and cable locks .....	076
Frame locks and battery locks .....	086
Special security .....	100
Brackets and Bags .....	126
ABUS OEM .....	144
Road .....	150
MTB .....	176
Urban .....	196
Kids .....	240
Helmet accessories .....	260
Shop in Shop .....	270
Index .....	281



# ABUS - MADE IN GERMANY

When August Bremicker and his sons founded ABUS in 1924, they had a lot of experience with engineering and craftsmanship – as well as a very clear vision: They wanted to create products that protected human life and property. It was a far-sighted corporate goal – paired with an expectation for quality right from the start. It was the start of a continuous success story. The ABUS brand became a synonym for security world-wide.



## HIGH-QUALITY MATERIALS

To be able to offer consistently high quality and security against every type of brutal and intelligent attack technique, we use the highest-quality materials at every price level. Complex hardening processes guarantee the best resistance in our materials. Our internal quality management check all materials before and during the production process to ensure every product has the high quality you demand.

## THE KEY TO SUCCESS

At ABUS, we design and build the tools and machines used in the production of our products in-house. That bundles knowhow, guarantees jobs, and strengthens identification. Our own engineering and toolmaking department concentrates exclusively on the development of bicycle and motorcycle locks. This ensures that we meet the tough requirements you place on your bicycle or motorcycle lock every day.

## ENSURING CONSISTENCY

In our own ABUS test laboratory, we routinely carry out tests and attacks on our products to ensure our products offer consistently high quality.

Among others we make sure our locks are resistant to:

- Ice spray attacks and freezing conditions at  $-40^{\circ}\text{C}$
- Twisting, pulling, hammering and sawing attacks with help of our manual or machine tests
- Rust by simulating highly corrosive weather conditions

  
Made in Germany

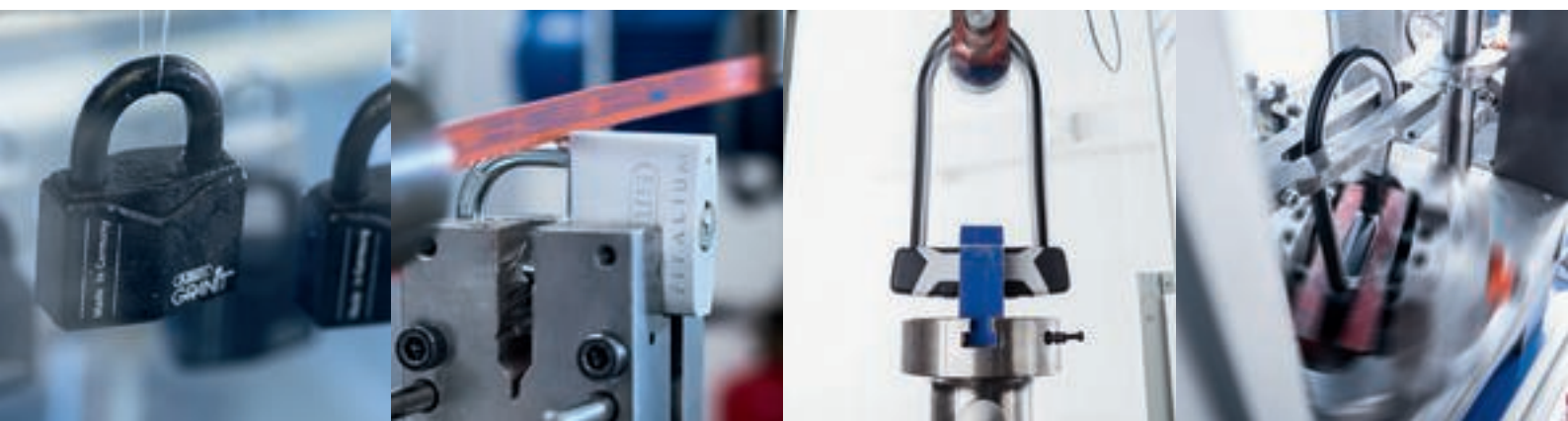

# APPROVALS

ABUS locks are tested and approved by independent testing institutions in a number of European countries. As every test lab use different tools, techniques and machines to test both security and quality we are very proud of the high number of different approvals given to ABUS products. If a lock can pass the varying test requirements in many different countries you can be sure it is of the highest possible quality and security.

The following seals of approval confirm the outstanding security of ABUS cycle locks:



Svensk Brand- och  
Säkerhetscertifiering AB  
Stockholm, Sweden



Norges Forsikringsforbund  
Oslo, Norway



Dansk Varefakta Naevn  
Copenhagen, Danmark



Finanssiala  
Helsinki, Finland



ART (ANWB, RAI, Theft Insurers)  
Nieuwegen, The Netherlands



Sold Secure  
Rugby, Great Britain



FUB 2-roues  
Valence, France



Test Seal VdS  
Cologne, Germany



ABUS Seal for Ice Spray Test  
Volmarstein, Germany



SRA  
Paris, France





## ONE KEY™ SIMPLE . INDIVIDUAL .

### HAVE CUSTOM BIKE LOCKS MADE - OPERATE EVERYTHING WITH JUST ONE KEY!

A primary lock, a frame lock, a padlock, and even a battery lock for e-bikes - if you want to secure your bike properly, you need a lot of locks. That is why we at ABUS, with the ONE KEY system, offer the ability to produce locks for your customers in such a way that they can all be operated with one key. No mess, no looking for keys.

### HOW ONE KEY™ WORKS

It's quite simple. Each ABUS lock has an individual key code with which spare keys or matching "keyed alike" locks can be made - even years after purchase. All that matters is that the locks from ABUS have the same type of cylinder installed.

### HERE'S HOW IT WORKS



The order is conveniently placed via the Partner-Portal.



1. Read key code from code card



2. Choose suitable products at your retailer



3. 1 week to manufacture your custom product



4. Pick up at retailer or ship to home



## FAMILIAR FACE – NEW DESIGN

As a manufacturer of cylinders and bicycle locks, ABUS has the unique opportunity in the market to manufacture custom locks so that they can all be operated with one key – or “keyed alike”. It is important that the locks be compatible with each other for this purpose.

So far we have marked our products and campaigns with these icons:



With YourPlus™, we have combined all locks that have a Plus cylinder.

This icon currently indicates that this lock can be keyed alike.

**FROM NOW ON, WE'RE BRINGING EVERYTHING TOGETHER UNDER ONE KEY™ – A CLEAR PROMISE FOR MORE CONVENIENCE.**

## OVERVIEW OF KEYED ALIKE PRODUCTS

### PRODUCTS WITH XPLUS CYLINDER

GRANIT™ Super Extreme 2500  
 GRANIT™ Extreme 59  
 GRANIT XPlus™ 540  
 BORDO GRANIT XPlus™ 6500K  
 BORDO GRANIT XPlus™ 6500KA  
 BORDO™ 6200K  
 BORDO™ 6000K  
 BORDO™ 6000KA  
 Steel-0-Chain™ 9809K  
 Steel-0-Chain™ 9808K  
 GRANIT City Chain XPlus™ 1060  
 6950M XPlus™  
 WCH90

### PRODUCTS WITH PLUS CYLINDER

GRANIT™ Plus 640  
 GRANIT™ Plus 470  
 CityChain™ 1010

### EC CYLINDER

GRANIT™ 460  
 PHANTOM™ 8960

Surcharge  
 for manufacturing  
 only 10%  
 of the price  
 of the lock



## MAXIMUM CONVENIENCE FOR YOUR CUSTOMERS

- + no frustrating searching for the right key
- + for e-cyclists with battery lock, frame lock, bike lock
- + for families with multiple locks
- + for couples or friends sharing their bike

# ONE KEY PRICE LIST

## U-SHACKLE LOCKS

98210	2500/165AB230 +USH2500 gl. Granit Super Extreme
95475	540/160HB300+SH B gl. One Key GRANIT XPLUS
95474	540/160HB230+SH B gl. One Key GRANIT XPLUS
04409	540/160HB300+EaZy KF gl. One Key GRANIT XPLUS
04407	540/160HB230+EaZy KF gl. One Key GRANIT XPLUS
04410	540/160HB300+USH540 gl. One Key GRANIT XPLUS
04408	540/160HB230+USH540 gl. One Key GRANIT XPLUS
70665	540/160HB300 gl. One Key GRANIT XPLUS
04411	540/160HB230 gl. One Key GRANIT XPLUS
81461	640/135HB230 BK TexKF gl. One Key GRANIT PLUS
81460	640/135HB150 BK gl. One Key GRANIT PLUS
81459	640/135HB150 BK/RD gl. One Key GRANIT PLUS
95473	470/150HB300+SH B gl. One Key GRANIT PLUS
95472	470/150HB230+SH B gl. One Key GRANIT PLUS
81464	470/150HB300+EaZy KF gl. One Key GRANIT PLUS
81462	470/150HB230+EaZy KF gl. One Key GRANIT PLUS
81465	470/150HB300+USH gl. One Key GRANIT PLUS
81463	470/150HB230+USH gl. One Key GRANIT PLUS
95471	460/150HB300+SH B gl. One Key GRANIT
95470	460/150HB230+SH B gl. One Key GRANIT
04417	460/150HB300+USH gl. One Key GRANIT
04416	460/150HB230+USH gl. One Key GRANIT

## FOLDING LOCKS

67593	6500K/120 BK SH gl. One Key BORDO Granit XPlus
91203	6500K/90 BK SH gl. One Key BORDO Granit XPlus
64172	6500KA/90 BK SH gl. One Key BORDO Granit XPlus
67533	6000K/120 BK SH gl. One Key BORDO Big
67509	6000K/90 BK SH gl. One Key BORDO

## FOLDING LOCKS

67464	6000K/120 BK ST gl. One Key BORDO Big
67463	6000K/90 BK ST gl. One Key BORDO
67614	6000KA/120 BK SH gl. One Key BORDO Big Alarm
67608	6000KA/90 BK SH gl. One Key BORDO Alarm
81380	6000/120 BK SH gl. One Key BORDO Big
72987	6000/90 BK SH gl. One Key BORDO
83747	6000A/120 BK SH gl. One Key BORDO Big Alarm
80940	6000A/90 BK SH gl. One Key BORDO Alarm
34572	5900/90 BK ST gl. One Key BORDO Classic
78065	6055K/60 BK gl. One Key BORDO LITE MINI
82574	6055K/60 RD gl. One Key BORDO LITE MINI

## CHAIN LOCKS

42277	1060/170 gl. One Key City Chain XPlus
42275	1060/140 gl. One Key City Chain XPlus
30595	1060/110 gl. One Key City Chain XPlus
42276	1060/85 gl. One Key City Chain XPlus
21578	1010/170 black gl. One Key City Chain
21577	1010/140 black gl. One Key City Chain
21576	1010/110 black gl. One Key City Chain
71549	1010/85 black gl. One Key City Chain
95555	9809K/140 BK gl. One Key Steel-0-Chain
95556	9809K/170 BK gl. One Key Steel-0-Chain
95554	9809K/110 BK gl. One Key Steel-0-Chain
95553	9809K/85 BK gl. One Key Steel-0-Chain

**CHAIN LOCKS**

97171	9808K/170 BK gl. One Key Steel-0-Chain
97170	9808K/140 BK gl. One Key Steel-0-Chain
97169	9808K/110 BK gl. One Key Steel-0-Chain
97172	9808K/85 BK gl. One Key Steel-0-Chain

**STEEL-0- FLEX LOCKS**

77088	8960/110 TexFL gl. One Key PHANTOM
78593	8960/85 KF gl. One Key PHANTOM

**FRAME LOCKS**

96220	6950M AM NR BK OE gl. One Key XPLUS
95905	6950M AM R BK OE gl. One Key XPLUS
96218	6950ML NR BK OE gl. One Key XPLUS
96219	6950ML R BK OE gl. One Key XPLUS
90764	5955 NR BK gl. One Key PRO SHIELD XPLUS
91147	5955 R BK gl. One Key PRO SHIELD XPLUS
91145	5755L NR BK OE gl. One Key SHIELD XPLUS
91146	5755L R BK OE gl. One Key SHIELD XPLUS
79846	5950 NR BK gl. One Key PRO SHIELD
87766	5950 R BK gl. One Key PRO SHIELD
81477	5750L NR BK gl. One Key SHIELD PLUS
81476	5750L R BK gl. One Key SHIELD PLUS

**BATTERY LOCKS**

95510	BLO BOS IT3 XPlus OE gl.
95511	BLO BOS IT2.1 XPlus OE gl.
83447	BLO BOS IT2.1 PLUS gl.
68734	BLO BOS DT2 XPlus OE gl.
81479	BLO BOS DT2 PLUS gl.
90913	BLO BOS RT2 XPlus OE gl.

**BATTERY LOCKS**















73289	BLO BOS RT2 PLUS gl.
91226	BLO CUB IT2.B3 XPlus OE gl.
91225	BLO CUB IT2 XPlus OE gl.
91224	BLO CUB IT1.B3 XPlus OE gl.
91223	BLO CUB IT1 XPlus OE gl.
95529	BLO KTM IT1 XPlus OE gl.
95521	BLO WIN IT4 PLUS OE gl.
87544	BLO WIN IT3 PLUS OE gl.
87542	BLO WIN IT1 PLUS OE gl.
95513	BLO ZEG IT4 XPlus OE gl.
95516	BLO ZEG IT3 PLUS OE gl.

















## KEY SERVICE

The ABUS key service allows you to order new keys for existing locks.

Just select the required blank, enter the desired coding and the key will be delivered within no time.



	Cylinder type	EAN-No.:	Item no
	XPlus	4003318246579	24657 9
	Plus	4003318062278	06227 8
	8N	4003318816635	81663 5
	6N	4003318709777	70977 7
	6S	4003318995095	99509 5
	T82	4003318561139	56113 9
	T83	4003318844867	84486 7
	F82	4003318815263	81526 3
	P82	4003318827044	82704 4
	E6	4003318822452	82245 2
	KC 54	4003318815270	81527 0
	ML54	4003318815287	81528 7
	NW52 black	4003318546938	54693 8
	NW72 red	4003318547539	54753 9

	Cylinder type	EAN-No.:	Item no
	PL1	4003318818684	81868 4
	RH 5	4003318835957	83595 7
	RH EC	4003318267666	26766 6
	U72	4003318815294	81529 4
	U73	4003318815300	81530 0
	U74	4003318815317	81531 7
	V61	4003318815324	81532 4
	V62	4003318815348	81534 8
	V63	4003318815331	81533 1
	V64	4003318815355	81535 5
	V65	4003318815362	81536 2
	Z72	4003318815379	81537 9
	Z73	4003318815386	81538 6
	Z74	4003318815393	81539 3
	ABUS - Voucher for Plus or XPlus	4003318043185	04318 5
	ABUS - Voucher for ABUS other	4003318290015	29001 5

# THE ABUS LEVEL SYSTEM

Finding the right lock for your customer requires a few questions that can help in the selection process. A lock must not only be secure, it must also suit the user.

The questions below can help you figure out what your customer is looking for:

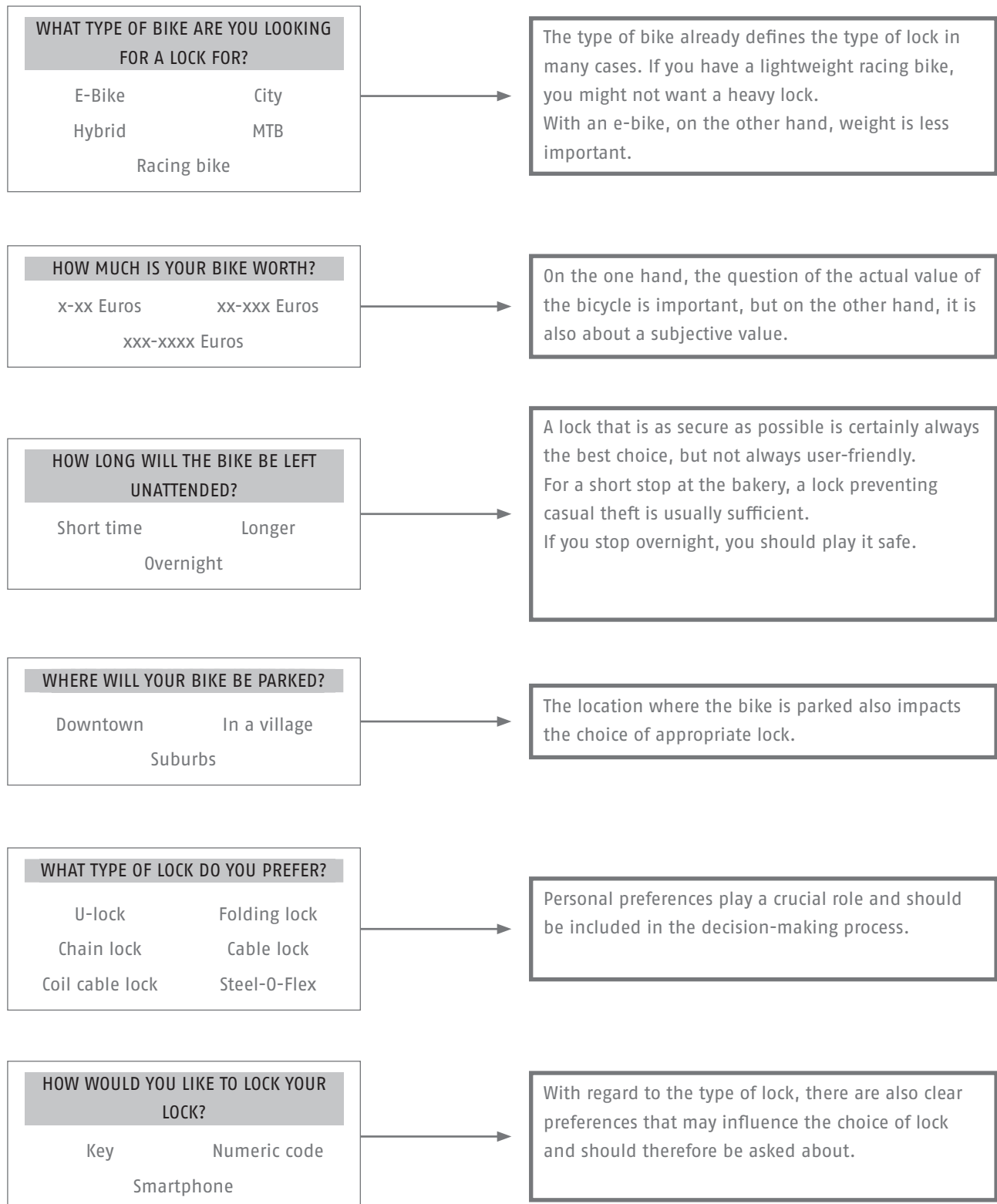

In the sales conversation, you get the best feel for your customer and a sense for what they value.

Many questions are rather soft factors and have an influence on the choice of the lock, but not so much on the choice of the appropriate security level.

The most important factors in determining the level of protection required are the bicycle value, location and length of time the bike is left.

For this, we recommend the following reference:

	Rural region 	Suburban 	Urban 
Quickstop	2 - 4	7 - 10	13 - 15
Few hours	5 - 6	10 - 13	13 - 15
All day	6 - 7	13 - 15	15
Overnight	7 - 10	15	15

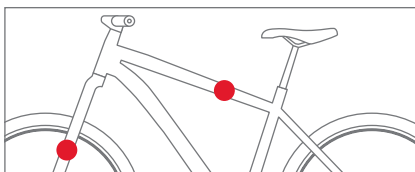

Lock your bike in illuminated and well frequented areas.

Secure you bike to an immovable object and lock both, frame and front wheel.

Keep the lock as high as possible and pass it through the frame as much as you can. This makes it harder to attack.

**U-SHACKLE LOCKS**



**GRANIT™  
SUPER EXTREME 2500**



Page 16

**GRANIT™ PLUS 470**



Page 20

**ULTRA 410K**



Page 24

**GRANIT XPLUS™ 540**



Page 18

**ULTIMATE 420K**



Page 21

**FACILO 32**



Page 25

**GRANIT™ PLUS 640**



Page 19

**GRANIT™ 460**



Page 22

**402**



Page 25

# GRANIT™ SUPER EXTREME 2500

## SECURITY LEVEL



## FEATURES



XPlus™



USH2500



## TECHNICAL DATA

- 31×28 mm thick shackle with integrated hardened square steel core and plastic coating
- The lock shackle and body are better protected against brutal saw attacks with battery angle grinders thanks to a special wolfram carbide material compound
- Double locking of the shackle in the lock body
- The shackle, housing and structural parts of the locking mechanism are made of specially hardened steel
- ABUS XPlus™ cylinder for extremely high protection against manipulation, e.g. picking
- ABUS Power Cell technology offers maximum protection against impacts and attempts to break open the lock
- Two keys included in the scope of delivery
- ABUS Code Card for spare and replacement keys
- Flexible and firm holder fixation with coated metal fixing straps



## TECHNOLOGY

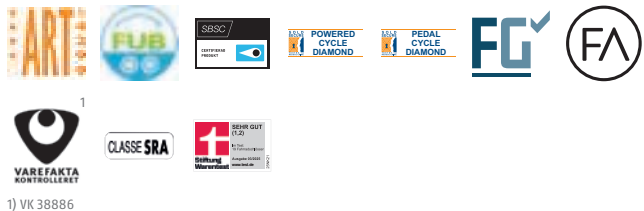

## TEST SEALS



1) VK 38886

Ref. No.	Art. No.	EAN 4003318	 mm	 mm	 mm	Weight g	Box Qty
2500/165HB230	10099680-01	99680 1	102	230	28	2230	4
2500/165HB230 + USH2500	10096050-01	96050 5	102	230	28	2470	3



Security Tech Germany



# GRANIT SUPER EXTREME 2500 FOR EXTREME SITUATIONS

When we combine our best technologies to create an extreme lock - the result is the GRANIT SUPER EXTREME 2500! Extreme resistance against extreme attacks, even if the opponent is the cordless grinder!

[abus.com](https://abus.com)



EUROBIKE



WINNER

AWARD 2023

  
Made in Germany

# GRANIT™ XPLUS™ 540

## SECURITY LEVEL



## FEATURES



XPlus™



USH 540



SH B



EaZy KF



## TECHNICAL DATA

- 13 mm hardened square shaft parabolic shackle
- ABUS power cell technology offers the highest level of protection against impacts and attempts to break open the lock
- The shackle, housing and the structural parts of the locking mechanism are made of specially hardened steel
- ABUS XPlus cylinder for the highest level of protection against tampering, e.g. picking
- Automatic keyhole cover to protect against dirt and corrosion



## TECHNOLOGY



## TEST SEALS



1) VK 30330

Ref. No.	Art. No.	EAN 4003318	 mm	 mm	 mm	Weight g	Box Qty
540/160HB230	10011161-01	11161 7	108	230	17	1500	6
540/160HB300	10011179-01	11179 2	108	300	17	1700	6
540/160HB230 + USH540	10011186-01	11186 0	108	230	17	1650	4
540/160HB300 + USH540	10011188-01	11188 4	108	300	17	1850	4
540/160HB230 + SH B	10069076-01	69076 1	108	230	17	1650	3
540/160HB300 + SH B	10069075-01	69075 4	108	300	17	1850	3
540/160HB230 + EaZy KF	10011183-01	11183 9	108	230	17	1600	4
540/160HB300 + EaZy KF	10011185-01	11185 3	108	300	17	1800	4

# GRANIT™ PLUS 640

## SECURITY LEVEL



## FEATURES



Plus



Bracket TexKF Mini



## VERSIONS



HB150 black



HB230 black

## TECHNICAL DATA

- Hardened 12 mm round shackle
- The shackle, the lock body and the structural parts of the locking mechanism are manufactured using specially hardened steel
- Priority given to the use of weight-optimised special alloys and lightweight materials
- ABUS Plus cylinder including automatic cover for maximum protection against attempts at manipulation, e.g. picking



## TECHNOLOGY



## TEST SEALS



1) Only applies to the SE version (item no. 72510) 2) VK 31644

Ref. No.	Art. No.	EAN 4003318	 mm	 mm	 mm	Weight g	Box Qty
640/135HB150 red	10039704-01	39704 2	83	150	15	800	4
640/135HB150 black	10039702-01	39702 8	83	150	15	800	4
640/135HB230 + TexKF black	10039703-01	39703 5	83	230	15	1030	4

# GRANIT™ PLUS 470

## SECURITY LEVEL



## FEATURES



Plus



USH 460/470/32



SH B



EaZy KF

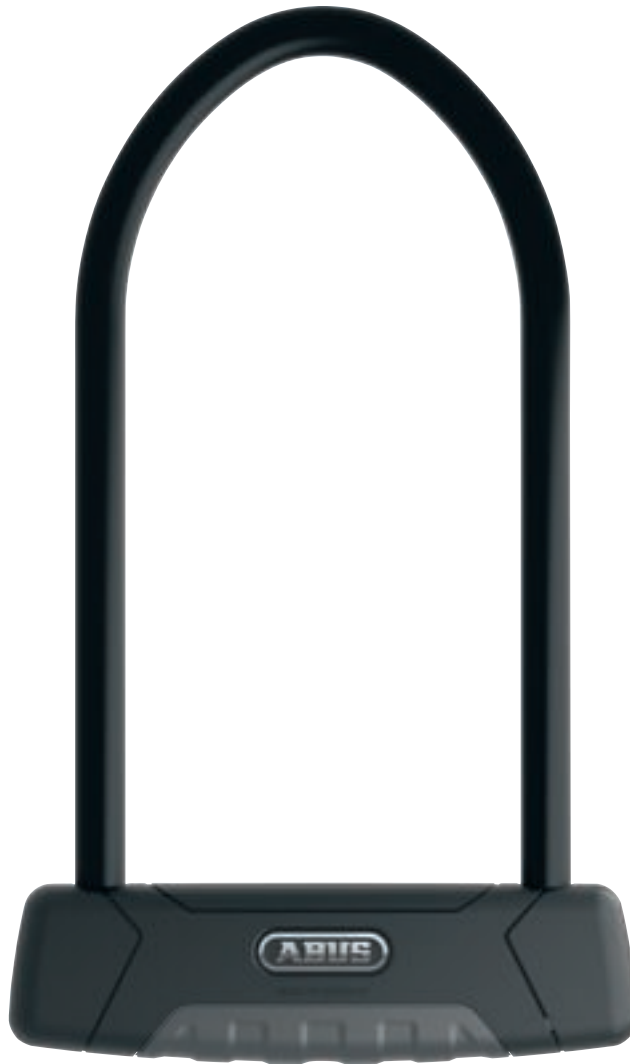

## TECHNICAL DATA

- Hardened 12 mm parabolic shackle
- ABUS Power Cell technology provides outstanding protection against attempts to remove the lock by hitting or pulling
- The shackle, the body and the load-bearing parts of the locking mechanism are manufactured from specially hardened steel
- Automatic cover to protect the keyhole from contamination and corrosion

## TECHNOLOGY



## TEST SEALS



1) VK 30328

Ref. No.	Art. No.	EAN 4003318	mm	mm	mm	Weight g	Box Qty
470/150HB230 + USH470	10011249-01	11249 2	109	230	14	1260	4
470/150HB300 + USH470	10011251-01	11251 5	109	300	14	1320	5
470/150HB230 + SH B	10069073-01	69073 0	109	230	14	1290	3
470/150HB300 + SH B	10069072-01	69072 3	109	300	14	1350	4
470/150HB230 + EaZy KF	10011189-01	11189 1	109	230	14	1240	4
470/150HB300 + EaZy KF	10011194-01	11194 5	109	300	14	1300	4

# ULTIMATE 420K

## SECURITY LEVEL



## FEATURES



6N



USH



## VERSIONS



420K/150HB140



420K/150HB140  
+ Cobra™ 10/120



420K/170HB230



420K/170HB230  
+ Cobra™ 10/120

## TECHNICAL DATA

- 14 mm thick round shackle made of specially hardened steel
- High-quality lock cylinder for high protection against tampering, e.g. picking
- The shackle, housing and structural parts of the locking mechanism are made of specially hardened steel
- New, standardised lock body casing design
- Colours with high recognition value



## TECHNOLOGY



## TEST SEALS



1) VK 36174

Ref. No.	Art. No.	EAN 4003318	 mm	 mm	 mm	Weight g	Box Qty
420K/150HB140 USH	10038113-01	38113 3	78	140	14	1120	6
420K/150HB140 USH + Cobra™ 10/120	10040588-01	40588 4	78	140	14	1450	6
420K/170HB230 USH	10094377-01	94377 5	103	230	14	1470	6
420K/170HB230 USH + Cobra™ 10/120	10040998-01	40998 1	103	230	14	1800	6

# GRANIT™ 460

## SECURITY LEVEL



## FEATURES



RH EC



USH 460/470/32



## TECHNICAL DATA

- Hardened 12 mm parabolic shackle
- The shackle, the lock body and the structural parts of the locking mechanism are manufactured using specially hardened steel
- ABUS Extra Class cylinder with coded reversible key

## TECHNOLOGY



## TEST SEALS



Ref. No.	Art. No.	EAN 4003318	mm	mm	mm	Weight g	Box Qty
460/150HB230 + USH460	10011253-01	11 253 9	109	230	14	1000	4
460/150HB300 + USH460	10011255-01	11 255 3	109	300	14	1250	5

Cannondale



ABUS

ULTRA 410

# ULTRA 410K

## SECURITY LEVEL



## FEATURES



6N



Bracket SH 34



## VERSIONS



410K/150HB140



410K/150HB140  
+ Cobra™ 10/120



410K/150HB180



410K/150HB180  
+ Cobra™ 10/120

## TECHNICAL DATA



- 12 mm thick round shackle made of specially hardened steel
- High-quality lock cylinder for high protection against tampering, e.g. picking
- The shackle, housing and structural parts of the locking mechanism are made of specially hardened steel
- New, standardised lock body casing design
- Colours with high recognition value

## TECHNOLOGY



## TEST SEALS



Ref. No.	Art. No.	EAN 4003318	 mm	 mm	 mm	Weight g	Box Qty
410K/150HB140 green SH	10094374-01	94374 4	81	140	12	880	6
410K/150HB140 green SH + Cobra™ 10/120	10040996-01	40996 7	81	140	12	1210	6
410K/150HB180 green SH	10041027-01	41027 7	81	180	12	895	6
410K/150HB180 green SH + Cobra™ 10/120	10094375-01	94375 1	81	180	12	1230	6
410K/170HB230 green SH	10040587-01	40587 7	106	230	12	1130	6
410K/170HB230 purple SH	10038111-01	38111 9	106	230	12	1130	6
410K/170HB230 green SH+ Cobra™ 10/120	10094376-01	94376 8	106	230	12	1460	6

## FACILO 32

### FEATURES



U74



USH 460/470/32

### SECURITY LEVEL



### TECHNICAL DATA



- Hardened 12 mm round shackle
- ABUS top-quality locking cylinder
- PVC casing to prevent damage to paintwork

### TECHNOLOGY



### TEST SEALS



Ref. No.	Art. No.	EAN 4003318	 mm	 mm	 mm	Weight g	Box Qty
32/150HB230 + USH32	10037492-01	37492 0	109	230	12	1035	6
32/150HB300 + USH32	10037887-01	37887 4	109	300	12	1160	6

## 402

### FEATURES



Bracket SH 34

### SECURITY LEVEL



### TECHNICAL DATA

- 11 mm, hardened steel round shackle
- Double-locking mechanism securing the shackle in the lock body
- The shackle, the body and the load-bearing parts of the locking mechanism are manufactured using specially hardened steel
- Special, modern design of the lock body casing allows for optimum handling

### TECHNOLOGY



### TEST SEALS



Ref. No.	Art. No.	EAN 4003318	 mm	 mm	 mm	Weight g	Box Qty
402/170HB230 yellow SH34	10086742-01	86742 2	110	230	11	890	6

**FOLDING LOCKS**



**BORDO™ ONE  
6500A**



Page 30

**BORDO GRANIT™  
6500KA**



Page 31

**BORDO GRANIT™  
6500K**



Page 32

**BORDO™  
6200K**



Page 33



**BORDO ONE  
6000A FINGERPRINT**



Page 34

**BORDO™ ONE  
6000A**



Page 35

**BORDO™  
6000KA**



Page 36

**BORDO™  
6000K**



Page 37

**BORDO™  
6000C**



Page 38

**BORDO™  
6000C LED**



Page 39

**UGRIP BORDO™  
5700K**



Page 40

**UGRIP BORDO™  
5700C**

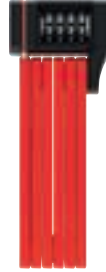

Page 41

**BORDO™  
LITE 6055K MINI**



Page 42

**BORDO™  
LITE 6055K**



Page 42

**BORDO™  
LITE 6055C MINI**



Page 43

**BORDO™  
LITE 6055C**



Page 43



BIKE DOG BREWING CO  
BIKEDOGBREWING.COM



# BORDO™ ONE 6500A

## SECURITY LEVEL



## FEATURES



Bracket SH BORDO  
6500A SmartX



SmartX RC



## TECHNICAL DATA

- 5.5 mm thick bars, with extra-soft 2-component coating
- Easy operation via the ABUS One app (previously SmartX) – for iOS and Android
- Bike lock can be opened and locked without a key – keyless function based on proven ABUS SmartX™ Bluetooth® technology
- Alarm function with min. 100 dB for 15 seconds, then automatic re-arming
- 3D position detection – detects vibrations and the smallest of movements in all three dimensions and triggers an alarm
- Smart alarm – the lock only emits a short warning tone in the event of minor and brief vibrations, e.g. if a football bounces nearby
- USB-C port
- Storage of the bike's last parking location
- LED light indicates battery and charging status
- RC variant can be operated via included remote control (for all other variants, the remote control is available separately)
- Incl. SH lock carrier for transport on the bike

## TECHNOLOGY



## TEST SEALS



Ref. No.	Art. No.	EAN 4003318	 cm	Weight g	Box Qty
6500A/110 black SH BORDO One	10061495-01	61495 8	110	2300	3
6500A/110 black SH RC BORDO One	10061497-01	61497 2	110	2300	3
Bracket SH 6500A One	10063488-01	63488 8		148	1
SmartX™ RC	10064000-01	64000 1		70	39

# BORDO GRANIT™ 6500KA

## SECURITY LEVEL



## FEATURES



Bracket SH 6500K/90



Folding locks

## TECHNICAL DATA

- 5.5 mm thick bars, extra-soft coating to prevent damage to paintwork
- The bars and body are made of specially hardened steel
- Alarm function with at least 100 dB for 15 seconds followed by automatic re-arming
- 3-D positional alarm detection - detects shocks and movements in all dimensions
- Smart alarm - the lock only emits a small warning tone in the event of small and short shocks, e.g. if a football hits the bike
- ABUS Link Protection Shield for high protection against attacks on the joints
- ABUS XPlus cylinder for the greatest protection against manipulation, e.g. picking
- Acoustic signal indicates battery status and active status
- Transport position - do not insert the locking bar completely, so that the alarm is inactive
- Alarm position - insert locking bar completely; the alarm will be activated after locking
- Speaker shielded behind the locking bar
- Incl. SH lock carrier for transport on the bike

## TECHNOLOGY



## TEST SEALS



1) VK 38045

Ref. No.	Art. No.	EAN 4003318	 cm	Weight	VE
6500KA/90 black SH	10069052-01	69052 5	90		
Bracket SH 6500K/90	10069051-01	69051 8			

# BORDO GRANIT™ 6500K

## SECURITY LEVEL



## FEATURES



## VERSIONS



## TECHNICAL DATA

- 5.5 mm thick bars, extra-soft coating to prevent damage to paintwork
- The bars, housing and the structural parts of the locking mechanism are manufactured from specially hardened steel
- ABUS Link-Protection-Shield offers high protection at the links
- ABUS XPlus cylinder for the greatest protection against manipulation, e.g. picking
- This lock can be made keyed alike to a variety of other locks
- Incl. SH lock carrier for transport on the bike

## TECHNOLOGY



## TEST SEALS



1) VK 37547

Ref. No.	Art. No.	EAN 4003318	 cm	Weight g	Box Qty
6500K/90 black SH	10061498-01	61498 9	90	1670	4
6500K/90 black SH TwinSet	10061499-01	61499 6	90	1670 je Schloss	2
6500K/120 black SH	10062115-01	62115 4	120	2470	3
Bracket SH 6500K/90	10069051-01	69051 8		195	3
Bracket SH 6500K/120	10096279-01	96279 0		230	1

# BORDO™ 6200K

NEW

## SECURITY LEVEL



## FEATURES



XPlus™



Bracket SH 6200K/90



Bracket SH 6200K/120



## VERSIONS



6200K/120

Folding locks

## TECHNICAL DATA

- Hard-as-steel resistance: bars made of hardened steel with plastic coating to protect against paint damage
- 360° rotatable lock body: allows more flexibility when locking
- Locking circumference 6200K/90: 94 cm
- Locking circumference 6200K/120: 125 cm
- ABUS XPlus cylinder: for extremely high protection against tampering, e.g. picking
- Transport and locking position: thanks to two insertion options in the lock body (only for 6200K/120)
- Key compartment: the holder offers a practical storage option for the key
- Storage compartment for tracker: an AirTag\* or SmartTag\*\* (Generation 1) can be hidden in the holder
- Quality lock: Made in Germany
- Scope of delivery: Folding lock, 2 keys, lock holder

## TECHNOLOGY



## TEST SEALS



1) 6200K/120: VK 41380 2) 6200K/90: VK 39285

Ref. No.	Art. No.	EAN 4003318	 cm	Weight g	Box Qty
6200K/90 SH BK	10099530-01	99530 9	94	1320	6
6200K/120 SH BK	10041655-01	41655 2	125	1634	6
Bracket SH 6200K/90	10094474-01	94474 1		165	3
Bracket SH 6200K/120	10041928-01	41928 7		165	3

# BORDO™ ONE 6000A FINGERPRINT

## SECURITY LEVEL



## FEATURES



Fingerprint



Bracket SH 6000/120



## TECHNICAL DATA

- 5 mm thick bars, extra-soft coating to prevent damage to paintwork
- Open without a key via fingerprint and the ABUS-One app
- Simple and secure integration of multiple users – up to 30 fingerprints can be memorised and additional users can be invited via app
- Practical 120 cm closing circumference
- 3D position detection – detects vibrations and the smallest of movements in all three dimensions and triggers an alarm
- Smart alarm – the lock only emits a short warning tone in the event of minor and brief vibrations, e.g. if a football bounces nearby
- USB-C connection for operating the lock in case the battery is flat when the lock is closed
- Storage of the bike's last parking location
- LED status display
- Incl. SH lock carrier for transport on the bike

## TECHNOLOGY



Ref. No.	Art. No.	EAN 4003318	 cm	Weight g	Box Qty
6000AF/120 BK SH	10099434-01	99434 0	120	1660	1
Bracket SH 6000/120	10061564-01	61564 1		132	3

# BORDO™ ONE 6000A

## SECURITY LEVEL



## FEATURES



Bracket SH 6000/120



SmartX RC



Folding locks

## TECHNICAL DATA

- 5 mm thick bars with extra-soft 2-component coating
- Smart locking system with Bluetooth® connection – user-friendly opening and closing without a key via smartphone
- Secure SmartX technology with integration in ABUS One
- Simple and secure integration of multiple users/smartphones
- Alarm function with min. 100 dB for 15 seconds, then automatic re-arming
- 3D position detection – detects vibrations and the smallest of movements in all three dimensions and triggers an alarm
- Smart alarm – the lock only emits a short warning tone in the event of minor and brief vibrations, e.g. if a football bounces nearby
- USB-C port
- Storage of the bike's last parking location
- LED status display
- RC variant can be operated via included remote control (for all other variants, the remote control is available separately)
- Incl. SH lock carrier for transport on the bike
- CR123A battery

## TECHNOLOGY



Ref. No.	Art. No.	EAN 4003318	 cm	Weight g	Box Qty
6000A/120 BK SH BORDO One	10097338-01	97338 3	120	1760	3
6000A/120 BK SH RC BORDO One	10097339-01	97339 0	120	1760	3
Bracket SH 6000/120	10061564-01	61564 1		132	3
SmartX™ RC	10064000-01	64000 1		70	39

# BORDO™ 6000KA

## SECURITY LEVEL



## FEATURES



XPlus™



Bracket SH 6000/90



Bracket SH 6000/120



## VERSIONS



6000KA/120 BK SH

## TECHNICAL DATA

- 5 mm bars with extra-soft yet resistant coating to prevent damage to paintwork
- The bars and body are made of specially hardened steel
- Alarm at a volume of at least 100 dB for 20 seconds, followed by automatic re-arming
- 3D position detection - detects vibrations and the smallest of movements in all three dimensions and triggers an alarm
- Smart alarm – the lock only emits a small warning beep in the event of minor and brief vibrations, e.g. if a football bounces nearby
- Acoustic signal indicates battery status and active status
- Bars are connected by special rivets
- ABUS XPlus cylinder for the greatest protection against manipulation, e.g. picking
- Incl. SH lock carrier for transport on the bike
- Transport position - do not insert the locking bar completely, so that the alarm is inactive
- Alarm position - insert locking bar completely; the alarm will be activated after locking
- Loudspeaker shielded behind locking bar

## TECHNOLOGY



## TEST SEALS



Ref. No.	Art. No.	EAN 4003318	 cm	Weight g	Box Qty
6000KA/90 black SH	10061500-01	61500 9	90	1450	4
6000KA/120 black SH	10062090-01	62090 4	120	1700	4
Bracket SH 6000/90	10061543-01	61543 6		115	3
Bracket SH 6000/120	10061564-01	61564 1		132	3

# BORDO™ 6000K

## SECURITY LEVEL



## FEATURES



## VERSIONS



6000K/90 TwinSet



6000K/120



6000K/120 TwinSet

Folding locks

## TECHNICAL DATA

- 5 mm bars with extra-soft yet resistant coating to prevent damage to paintwork
- The bars and the housing are made of specially hardened steel
- Bars are connected by special rivets
- ABUS XPlus cylinder for extremely high protection against manipulation, e.g. picking

## TECHNOLOGY



## TEST SEALS



1) 6000K/90: VK 37545 2) Only for 6000K/90

Ref. No.	Art. No.	EAN 4003318	 cm	Weight g	Box Qty
6000K/90 black SH	10062094-01	62094 2	90	1330	4
6000K/90 black SH TwinSet	10062095-01	62095 9	90	1330 je Schloss	2
6000K/90 black SH SF	10067865-01	67865 3	90	1330	4
6000K/90 black SHFL	10090973-01	90973 3	90	1330	4
6000K/120 black SH	10062091-01	62091 1	120	1546	4
6000K/120 black SH TwinSet	10067465-01	67465 5	120	1546 je Schloss	2
Bracket SH 6000/90	10061543-01	61543 6		115	3
Bracket SH SF 6000/90	10067866-01	67866 0		121	3
Bracket SH 6000/120	10061564-01	61564 1		132	3
Bracket SHFL 6000/90	10088886-01	88886 1		160	3

# BORDO™ 6000C

## SECURITY LEVEL



## FEATURES



Bracket SH 6000/90



Bracket SH SF



Bracket SHFL 6000/90



Bracket SH 6000/120

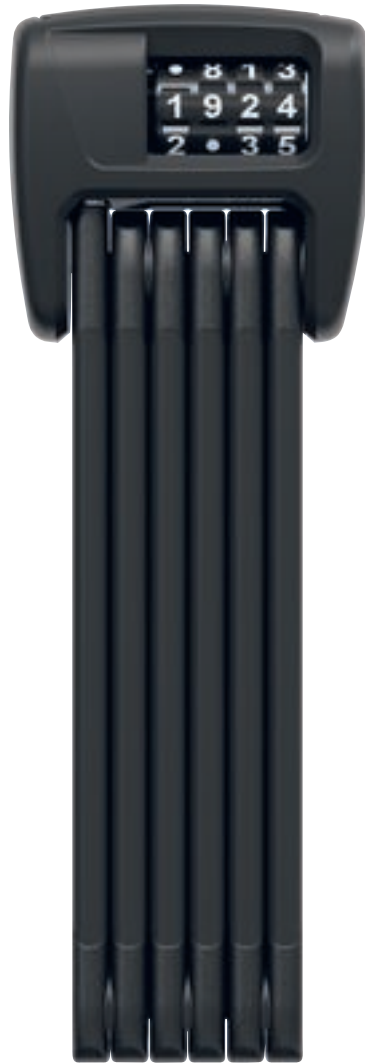

## VERSIONS



6000C/120

## TECHNICAL DATA

- 5 mm bars with extra-soft yet resistant coating to prevent damage to paintwork
- The bars and the housing are made of specially hardened steel
- Bars are connected by special rivets
- Two-component code dials ensures long-lasting legibility
- Opening code can be set individually
- Incl. SH lock carrier for transport on the bike

## TECHNOLOGY



## TEST SEALS



Ref. No.	Art. No.	EAN 4003318	 cm	Weight g	Box Qty
6000C/90 black SH	10067599-01	67599 7	90	1050	4
6000C/90 black SH SF	10069069-01	69069 3	90	1170	4
6000C/90 black SHFL	10090972-01	90972 6	90	1050	12
6000C/120 black SH	10099926-01	99926 0	120	1470	4
Bracket SH 6000/90	10061543-01	61543 6		115	3
Bracket SH SF 6000/90	10067866-01	67866 0		121	3
Bracket SH 6000/120	10061564-01	61564 1		132	3
Bracket SHFL 6000/90	10088886-01	88886 1		160	3

# BORDO™ 6000C LED

## SECURITY LEVEL



## FEATURES



Combo light



Bracket SH 6000/90



Bracket SHFL 6000/90

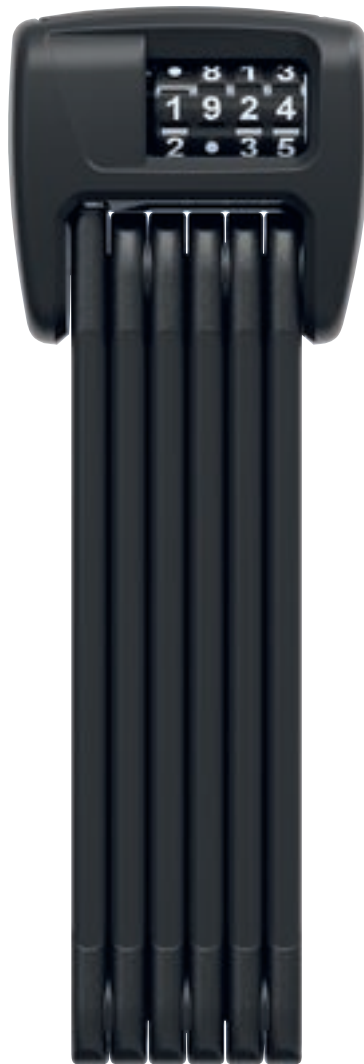

Folding locks

## TECHNICAL DATA

- 5 mm thick bars, extra-soft coating to prevent damage to paintwork
- The bars and the housing are made of specially hardened steel
- Bars are connected by special rivets
- Integrated LED lamp for illuminating the code dials
- A CR1220 button battery to power the LED lamp is included
- Two-component code dials ensures long-lasting legibility
- Opening code can be set individually
- Incl. SH lock carrier for transport on the bike

## TECHNOLOGY



## TEST SEALS



Ref. No.	Art. No.	EAN 4003318	 cm	Weight g	Box Qty
6000C/90 LED black SH	10069057-01	69057 0	90	1050	4
Bracket SH 6000/90	10061543-01	61543 6		115	3
Bracket SHFL 6000/90	10088886-01	88886 1		160	3

# UGRIP BORDO™ 5700K

## SECURITY LEVEL



## FEATURES



Bracket SH 5700/80



Bracket SH 5700K/100



## VERSIONS



5700K/80 lime



5700K/80 blue



5700K/80 red



5700K/100 black



5700K/100 lime



5700K/100 blue



5700K/100 red

## TECHNICAL DATA

- 5 mm steel bars
- Colour-matching lock body
- Bars are linked with special rivets
- High-quality automatic cylinder
- The "convenient transport mode" (CTM) provides an immediate use of the lock (only 5700/100)

## TECHNOLOGY



## TEST SEALS



Ref. No.	Art. No.	EAN 4003318	 cm	Weight g	Box Qty
5700K/80 black SH	10084425-01	84425 6	80	960	6
5700K/80 lime SH	10084427-01	84427 0	80	960	6
5700K/80 blue SH	10084426-01	84426 3	80	960	6
5700K/80 red SH	10084428-01	84428 7	80	960	6
5700K/100 black SH	10086743-01	86743 9	100	1090	6
5700K/100 lime SH	10086745-01	86745 3	100	1090	6
5700K/100 blue SH	10086744-01	86744 6	100	1090	6
5700K/100 red SH	10086746-01	86746 0	100	1090	6
Bracket SH 5700/80	10061566-01	61566 5		122	3
Bracket SH 5700K/100	10061571-01	61571 9		122	3

# UGRIP BORDO™ 5700C

## SECURITY LEVEL



## FEATURES



SH 5700/80

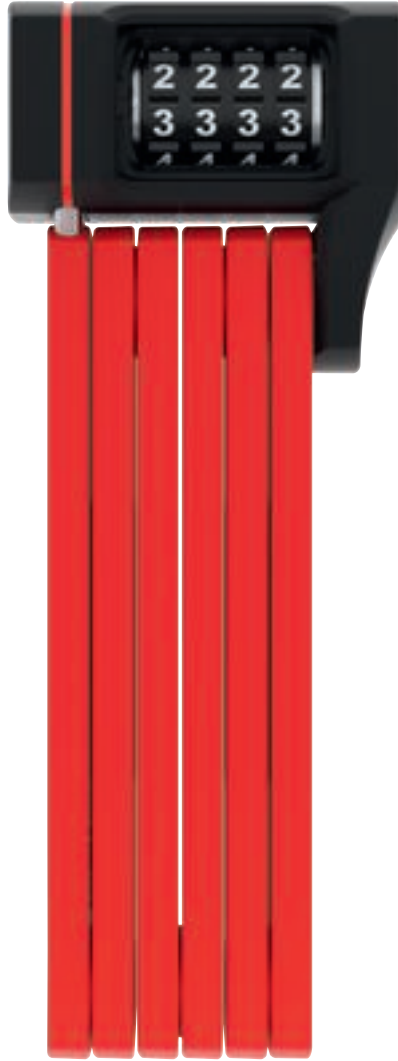

## VERSIONS



5700C/80 black



5700C/80 blue



5700C/80 lime

Folding locks

## TECHNICAL DATA

- 5 mm steel bars
- Bars are linked with special rivets
- Two component moulded digits guarantee life-long visibility
- Individually settable code

## TECHNOLOGY



## TEST SEALS



Ref. No.	Art. No.	EAN 4003318	 cm	Weight g	Box Qty
5700C/80 black SH	10087791-01	87791 9	80	960	6
5700C/80 blue SH	10087792-01	87792 6	80	960	6
5700C/80 lime SH	10087793-01	87793 3	80	960	6
5700C/80 red SH	10087794-01	87794 0	80	960	6
Bracket SH 5700/80	10061566-01	61566 5		122	3

# BORDO™ LITE 6055K MINI

## FEATURES



Bracket SH 6055



Bracket SR 6055



## SECURITY LEVEL



## VERSIONS



red



Movistar

## TECHNICAL DATA

- Special steel construction with colour-coordinated plastic coating to protect against paint damage
- The bars and the housing are made of particularly light materials and steel alloys
- Connection of the bars by special rivets
- Optimal compromise between safety and weight
- BK SH variant includes SH holder
- Ideal for the jersey pocket

## TECHNOLOGY



## TEST SEALS



Ref. No.	Art. No.	EAN 4003318	 cm	Weight g	Box Qty
6055K/60 black	10078060-01	78060 8	60	400	6
6055K/60 black SH	10062102-01	62102 4	60	500	6
6055K/60 red	10078061-01	78061 5	60	400	6
6055K/60 Movistar TEAM	10078062-01	78062 2	60	400	6
Bracket SH 6055	10061572-01	61572 6		60	3
Bracket SR 6055 Selle Royal	10063151-01	63151 1		64	3

# BORDO™ LITE 6055K

## FEATURES



Bracket SH 6055



Bracket SR 6055



## SECURITY LEVEL



## VERSIONS



red

## TECHNICAL DATA

- Special steel design, with colour-coordinated plastic casing to prevent damage to paintwork
- The bars and housing are manufactured using particularly lightweight materials and steel alloys
- Bars connected with special rivets
- High-quality automatic cylinder
- Including holder (SH or SH Selle Royal)

## TECHNOLOGY



## TEST SEALS



Ref. No.	Art. No.	EAN 4003318	 cm	Weight g	Box Qty
6055K/85 black SH	10078063-01	78063 9	85	550	6
6055K/85 black SR	10062104-01	62104 8	85	550	4
6055K/85 red SH	10078064-01	78064 6	85	550	6
Bracket SH 6055	10061572-01	61572 6		60	3
Bracket SR 6055 Selle Royal	10063151-01	63151 1		64	3

# BORDO™ LITE 6055C MINI

## FEATURES



Bracket SH 6055



Bracket SR 6055



## SECURITY LEVEL



## VERSIONS



red



Movistar

## TECHNICAL DATA

- Special steel design, with colour-coordinated plastic casing to prevent damage to paintwork
- The bars and housing are manufactured using particularly lightweight materials and steel alloys
- Bars connected with special rivets
- Two-component number reels guarantee long-term readability of the digits
- Individually configurable code
- Perfect security-weight ratio

## TECHNOLOGY



## TEST SEALS



Ref. No.	Art. No.	EAN 4003318	cm	Weight g	Box Qty
6055C/60 black	10062105-01	62105 5	60	460	6
6055C/60 black SH	10062110-01	62110 9	60	550	6
6055C/60 red	10062106-01	62106 2	60	460	6
6055C/60 Movistar TEAM	10062107-01	62107 9	60	460	6
Bracket SH 6055	10061572-01	61572 6		60	3
Bracket SR 6055 Selle Royal	10063151-01	63151 1		64	3

# BORDO™ LITE 6055C

## FEATURES



Bracket SR 6055



Bracket SH 6055



## SECURITY LEVEL



## VERSIONS



## TECHNICAL DATA

- Special steel design, with colour-coordinated plastic casing to prevent damage to paintwork
- The bars and housing are manufactured using particularly lightweight materials and steel alloys
- Bars connected with special rivets
- Two-component number reels guarantee long-term readability of the digits
- Individually configurable code
- Perfect security-weight ratio
- Incl. bracket (SH or SR)

## TECHNOLOGY



## TEST SEALS



Ref. No.	Art. No.	EAN 4003318	cm	Weight g	Box Qty
6055C/85 black SH	10062111-01	62111 6	85	576	6
6055C/85 black SR	10062113-01	62113 0	85	604	4
6055C/85 red SH	10062112-01	62112 3	85	576	6
Bracket SH 6055	10061572-01	61572 6		60	3
Bracket SR 6055 Selle Royal	10063151-01	63151 1		64	3

**CHAIN LOCKS**



**GRANIT CITYCHAIN  
XPLUS™ 1060**



Page 48

**IVY CHAIN  
9210**



Page 49

**CITYCHAIN™  
1010**



Page 50

**STEEL-O-CHAIN™  
9809K**



Page 51

**STEEL-O-CHAIN™  
9808K**



Page 51

**IVEN CHAIN  
8210**



Page 52

**8808C**



Page 53

**IVERA CHAIN  
7210**



Page 54

**IVERA CHAIN  
7210 COLOUR**



Page 55

**YARDO  
7807F**



Page 57

**YARNIT™  
4004K**



Page 58



**STEEL-O-CHAIN™  
8807K**



Page 59

**TRESOR  
6807C**



Page 60



**TRESOR  
6806C**



Page 61



**INFINITY LOOP  
1806**



Page 62

**CATENA  
6806K**



Page 63

**CATENA  
6806K NEON**



Page 63

**STEEL-O-CHAIN™  
5805K**



Page 64

**STEEL-O-CHAIN™  
5805C**



Page 64

**STEEL-O-CHAIN™  
4804K**



Page 65

**STEEL-O-CHAIN™  
4804C SYMBOLS**



Page 66

**STEEL-O-CHAIN™  
4804C**



Page 66

**1500 WEB**



Page 67

**1200 WEB**



Page 67

# GRANIT CITYCHAIN XPLUS™ 1060

## SECURITY LEVEL



## FEATURES



## VERSIONS



1060/110



1060/140



1060/170

## TECHNICAL DATA

- 10 mm hexagonal chain with textile sleeve to protect against damage to the paintwork
- ABUS Power Cell technology offers the highest level of protection against impacts and attempts to break the lock
- ABUS Power Link technology enables the chain to be connected directly to the Power Cell
- Interwoven coating of the lock body to protect against brutal methods of attack
- The chain, the lock body and supporting elements of the locking mechanism are made of specially hardened steel
- ABUS XPlus cylinder for the highest level of protection against tampering, e.g. picking
- Cover to protect the keyhole from contamination

## TECHNOLOGY



## TEST SEALS



1) Class C 2) VK 17218

Ref. No.	Art. No.	EAN 4003318	⌀ ↑ mm	●● cm	Weight g	Box Qty
1060/85 black	10028678-01	28678 0	10	85	2100	2
1060/110 black	10028623-01	28623 0	10	110	2650	2
1060/140 black	10028624-01	28624 7	10	140	3260	2
1060/170 black	10028625-01	28625 4	10	170	3750	2

# IVY CHAIN 9210

## SECURITY LEVEL



## FEATURES



NW72



## TECHNICAL DATA



- 10 mm square chain with new functional, durable and highly flexible synthetic fibre sleeve prevents damage to paintwork
- The chain, the lock body and supporting elements of the locking mechanism are made of specially hardened steel
- Ergonomically-shaped lock body
- Comes with a user-friendly reversible key

## TECHNOLOGY



## TEST SEALS



Ref. No.	Art. No.	EAN 4003318	 mm	 cm	Weight g	Box Qty
9210/85 black	10088691-01	88691 1	10	85	2440	2
9210/110 black	10088692-01	88692 8	10	110	3000	2
9210/140 black	10088693-01	88693 5	10	140	3650	1
9210/170 black	10088694-01	88694 2	10	170	4400	1

# CITYCHAIN™ 1010

## SECURITY LEVEL



## FEATURES



## VERSIONS



1010/110



1010/140



1010/170

## TECHNICAL DATA

- 9 mm hexagonal chain with fabric sleeve to prevent damage to the bicycle's paintwork
- The chain, the lock body and supporting elements of the locking mechanism are made of specially hardened steel
- ABUS Plus cylinder for high protection against manipulations, e.g. picking
- Automatic cover for the keyhole against dirt and corrosion

## TECHNOLOGY



## TEST SEALS



1) Class B

Ref. No.	Art. No.	EAN 4003318	⌀ mm	●●● cm	Weight g	Box Qty
1010/85 black	10033559-01	33559 4	9	85	1850	2
1010/110 black	10012042-01	12042 8	9	110	2200	2
1010/140 black	10012527-01	12527 0	9	140	2650	2
1010/170 black	10012528-01	12528 7	9	170	3200	2

# STEEL-O-CHAIN™ 9809K

## FEATURES





XPlus™



## SECURITY LEVEL



Ref. No.	Art. No.	EAN 4003318	 mm	 cm	Weight g	Box Qty
9809K/85 black	10095548-01	95548 8	9	85	2094	2
9809K/110 black	10095549-01	95549 5	9	110	2524	2
9809K/140 black	10095550-01	95550 1	9	140	3088	2
9809K/170 black	10095551-01	95551 8	9	170	3690	2

## TECHNICAL DATA

- 9 mm thick square chain
- The chain, housing and structural parts of the locking mechanism are made of specially hardened steel
- Automatic keyhole cover to prevent corrosion and the ingress of dirt
- ABUS XPlus cylinder for the greatest protection against manipulation such as picking
- Two keys included

## TECHNOLOGY



## TEST SEALS



1) 35210

# STEEL-O-CHAIN™ 9808K

## FEATURES





XPlus™



## SECURITY LEVEL



Ref. No.	Art. No.	EAN 4003318	 mm	 cm	Weight g	Box Qty
9808K/85 black	10095562-01	95562 4	8	85	1782	2
9808K/110 black	10095564-01	95564 8	8	110	2102	2
9808K/140 black	10095565-01	95565 5	8	140	2596	2
9808K/170 black	10095566-01	95566 2	8	170	2988	2

## TECHNICAL DATA

- 8 mm square chain
- The chain, housing and structural parts of the locking mechanism are made of specially hardened steel
- Automatic keyhole cover to prevent corrosion and the ingress of dirt
- ABUS XPlus cylinder for the greatest protection against manipulation such as picking
- Two keys included

## TECHNOLOGY



## TEST SEALS



1) Class B 2) 33324

# IVEN CHAIN 8210

## SECURITY LEVEL



## FEATURES



8N



## TECHNICAL DATA

- 8 mm square chain with a functional, durable and highly flexible IvyTex synthetic fibre sleeve prevents damage to paintwork
- The chain, the lock body and supporting elements of the locking mechanism are made of specially hardened steel



## TECHNOLOGY



## TEST SEALS



1) VK 24192

Ref. No.	Art. No.	EAN 4003318	 mm	 cm	Weight g	Box Qty
8210/85 black	10055152-01	55152 9	8	85	1800	2
8210/110 black	10055153-01	55153 6	8	110	2200	2
8210/140 black	10088288-01	88288 3	8	140	2660	2

# 8808C

## SECURITY LEVEL



## VERSIONS



russet red



jade green



black



Chain locks

## TECHNICAL DATA

- 8 mm chain with fabric sleeve to prevent damage to the bicycle's paintwork
- The chain is made of specially hardened steel
- Two-component number reels guarantee long-term readability of the digits
- Individually configurable code

## TECHNOLOGY



Ref. No.	Art. No.	EAN 4003318	 mm	 cm	Weight g	Box Qty
8808C/85 black	10061490-01	61490 3	8	85	1990	2
8808C/85 russet red	10061491-01	61491 0	8	85	1990	2
8808C/85 jade green	10061492-01	61492 7	8	85	1990	2
8808C/110 black	10061494-01	61494 1	8	110	2370	2

# IVERA CHAIN 7210

## SECURITY LEVEL



## FEATURES



Z73



Bracket IVERA RBU



ST 5950 2.0



ST 5050





## TECHNICAL DATA

- 7 mm square chain with a functional, durable and highly flexible IvyTex synthetic fibre sheath prevents damage to paintwork
- The chain, the lock body and supporting elements of the locking mechanism are made of specially hardened steel

## TECHNOLOGY



Ref. No.	Art. No.	EAN 4003318	 mm	 cm	Weight g	Box Qty
7210/85 black	10055141-01	55141 3	7	85	1300	2
7210/110 black	10055142-01	55142 0	7	110	1500	2
Bracket IVERA RBU	10058497-01	58497 8			125	1
ST 5950 2.0	10087510-01	87510 6			130	48
ST 5050	10040992-01	40992 9			166	60

# IVERA CHAIN 7210 COLOR

## SECURITY LEVEL



## FEATURES



Z73



Bracket IVERA RBU



ST 5950 2.0



ST 5050



## VERSIONS



desert tan



bike packing



anthracite



Chain locks

## TECHNICAL DATA

- 7 mm square chain with functional, long-life and highly-flexible mesh sleeve to prevent damage to the bicycle's paintwork
- The sleeve offers very high protection against abrasion and does not absorb any liquids e.g. water or oil
- The chain, the case as well as supporting elements of the locking mechanism are made of specially hardened steel

## TECHNOLOGY



Ref. No.	Art. No.	EAN 4003318	 mm	 cm	Weight g	Box Qty
7210/85 metal blue	10099556-01	99556 9	7	85	1300	2
7210/85 desert tan	10099553-01	99553 8	7	85	1300	2
7210/85 bike packing	10099551-01	99551 4	7	85	1300	2
7210/85 anthracite	10099559-01	99559 0	7	85	1300	2
7210/110 metal blue	10099555-01	99555 2	7	110	1500	2
7210/110 desert tan	10099554-01	99554 5	7	110	1500	2
7210/110 bike packing	10099552-01	99552 1	7	110	1500	2
7210/110 anthracite	10099558-01	99558 3	7	110	1500	2
Bracket IVERA RBU	10058497-01	58497 8			125	1
ST 5950 2.0	10087510-01	87510 6			130	48
ST 5050	10040992-01	40992 9			166	60



**ABUS**

# YARDO FINGERPRINT 7807F

## SECURITY LEVEL





Chain locks

## TECHNICAL DATA

- 7 mm thick round chain
- Lock body made of coated die-cast zinc
- CR2 battery included in the scope of delivery
- Precise capacitive fingerprint sensor
- Up to 20 individual fingerprints can be saved
- Double-bolted locking mechanism for improved protection against forced opening
- Quick locking without a fingerprint thanks to automatic locking
- Dustproof and weatherproof thanks to IP certification IP66 & IP68

## TECHNOLOGY



Ref. No.	Art. No.	EAN 4003318	 mm	 cm	Weight g	Box Qty
7807F/85 BK	10041001-01	41001 7	7	85	1246	2
7807F/110 BK	10040599-01	40599 0	7	110	1480	2

# YARNIT™ 4004K

## SECURITY LEVEL



## FEATURES



65



## VERSIONS



black / 85 cm



denim blue



midnight purple



sand stone

## TECHNICAL DATA

- Stylish: textile fibres in different colour shades are woven around the lock chain, creating a fashionable, rattle-free and strong knitted structure
- Secure: textile elements are interspersed with a steel cable – together with the hardened metal chain inside the lock, the lock offers solid protection against attacks with various tools
- Lightweight: perfect for all those who want a lightweight chain lock
- Resistant: with an overall diameter of 24 mm, the lock with security level 7 offers good protection in cases where there is a medium theft risk
- Practical: locks automatically – simply insert the locking bolt into the lock body, two keys are included in the scope of delivery for unlocking the lock
- Gentle on paintwork: the textile surface prevents scratches on the bike frame
- Picking-resistant: locking mechanism with anti-picking cylinder for greater protection against tampering with the cylinder
- Convenient transport: no rattling thanks to the textile coating – simply wrap the chain lock tightly around the bike frame or put it in your rucksack, no holder required

## TECHNOLOGY



Ref. No.	Art. No.	EAN 4003318	⌀ mm	●—● cm	Weight g	Box Qty
4004K/85 black	10046877-01	46877 3	24	85	720	1
4004K/110 black	10046878-01	46878 0	24	110	880	1
4004K/110 denim blue	10046879-01	46879 7	24	110	880	1
4004K/110 midnight purple	10050668-01	50668 0	24	110	880	1
4004K/110 sand stone	10046880-01	46880 3	24	110	880	1
4004K/140 black	10050637-01	50637 6	24	140	1120	1

# STEEL-O-CHAIN™ 8807K

## SECURITY LEVEL



## FEATURES



V63





## TECHNICAL DATA

- 7 mm thick square chain with textile sleeve that prevents damage to paintwork
- The chain, the lock body and supporting elements of the locking mechanism are made of specially hardened steel

## TECHNOLOGY



Ref. No.	Art. No.	EAN 4003318	 mm	 cm	Weight g	Box Qty
8807K/85 black	10071195-01	71195 4	7	85	1250	2
8807K/110 black	10082519-01	82519 4	7	110	1500	2

# TRESOR 6807C

## SECURITY LEVEL



## VERSIONS



light blue



rose blush



tec grey



sage green



Reflective

## TECHNICAL DATA

- Steel locking bolt ensures secure locking and can be inserted into the lock body from any position
- 7 mm thick square chain with textile coating to protect against paint damage
- The chain is made of specially hardened steel
- 2-component dials for long-lasting legibility of the digits
- Special scanning protection for increased security against unauthorised acquisition of the numerical code by tampering with the mechanism
- 4-digit numerical code can be set individually – this means up to 10,000 number combinations are possible
- Harmonious design thanks to the slim lock body made of durable material
- The “reflective” variant ensures increased visibility thanks to the reflective textile coating

## TECHNOLOGY



Ref. No.	Art. No.	EAN 4003318	⌀ ↑ mm	●○○ cm	Weight g	Box Qty
6807C/85 black	10046869-01	46869 8	7	85	1150	1
6807C/110 black	10050671-01	50671 0	7	110	1480	1
6807C/110 light blue	10046872-01	46872 8	7	110	1480	1
6807C/110 rose blush	10050670-01	50670 3	7	110	1480	1
6807C/110 tec grey	10046873-01	46873 5	7	110	1480	1
6807C/110 sage green	10050669-01	50669 7	7	110	1480	1
6807C/110 reflective	10047292-01	47292 3	7	110	1480	1
6807C/140 black	10046876-01	46876 6	7	140	1800	1

# TRESOR 6806C

## SECURITY LEVEL





## TECHNICAL DATA

- Steel locking bolt ensures secure locking and can be inserted into the lock body from any position
- 6 mm square chain with textile sleeve to protect against damage to the paintwork
- The chain is made of specially hardened steel
- 2-component dials for long-lasting legibility of the digits
- Special scanning protection for increased security against unauthorised acquisition of the numerical code by tampering with the mechanism
- 4-digit numerical code can be set individually – this means up to 10,000 number combinations are possible
- Harmonious design thanks to the slim lock body made of durable material

## TECHNOLOGY



Ref. No.	Art. No.	EAN 4003318	 mm	 cm	Weight g	Box Qty
6806C/85 black	10046868-01	46868 1	6	85	980	1

# INFINITY LOOP 1806

## SECURITY LEVEL



## FEATURES



6N



## VERSIONS



autumn orange



slow green

## TECHNICAL DATA

- 6 mm thick square chain
- Loop ring diameter 60 mm
- Double-loop function with two adjustable loops – one loop secures components such as the front or rear wheel, the other secures the bike frame
- Individually and infinitely adjustable length thanks to sliding lock body for flexible handling
- Durable and highly flexible IvyTex synthetic fibre coating protects the bike frame's paintwork from abrasion or scratches
- Quick locking without a key thanks to automatic locking – simply engage the sliding lock body

## TECHNOLOGY



Ref. No.	Art. No.	EAN 4003318	⌀ mm	∞ cm	Weight g	Box Qty
1806/110 black	10038114-01	38114 0	6	110	1400	2
1806/140 black	10038115-01	38115 7	6	140	1600	2
1806/140 autumn orange	10040999-01	40999 8	6	140	1600	2
1806/140 slow green	10040598-01	40598 3	6	140	1600	2

# CATENA 6806K

## FEATURES



6N



ST 5950 2.0



## SECURITY LEVEL



## VERSIONS



aqua



coral



reflective

Ref. No.

Art. No.

EAN  
4003318

mm

cm

Weight  
g

Box  
Qty

6806K/85 black	10090169-01	90169 0	6	85	920	6
6806K/85 aqua	10090282-01	90282 6	6	85	920	6
6806K/85 coral	10090284-01	90284 0	6	85	920	6
6806K/85 reflective	10069104-01	69104 1	6	85	920	6
6806K/110 black	10082511-01	82511 8	6	110	1160	6
6806K/110 reflective	10069105-01	69105 8	6	110	1160	6
ST 5950 2.0	10087510-01	87510 6			130	48
ST 5050	10040992-01	40992 9			166	60

## TECHNICAL DATA

- 6 mm thick square chain with textile sleeve that prevents damage to paintwork
- The chain is made of specially hardened steel

## TECHNOLOGY



# CATENA 6806K NEON

## FEATURES



6N



ST 5050



## SECURITY LEVEL



## VERSIONS



neon green



neon blue



neon orange

Ref. No.

Art. No.

EAN  
4003318

mm

cm

Weight  
g

Box  
Qty

6806K/85 neon green	10090290-01	90290 1	6	85	920	6
6806K/85 neon blue	10090289-01	90289 5	6	85	920	6
6806K/85 neon orange	10090291-01	90291 8	6	85	920	6
6806K/85 neon pink	10090292-01	90292 5	6	85	920	6
ST 5950 2.0	10087510-01	87510 6			130	48
ST 5050	10040992-01	40992 9			166	60

## TECHNICAL DATA

- 6 mm square chain with textile sleeve to protect against damage to the paintwork
- The chain and the housing are made of specially hardened steel

## TECHNOLOGY



# STEEL-O-CHAIN™ 5805K

## FEATURES



V65



## TECHNICAL DATA

- 5 mm square chain with textile sleeve to protect against damage to the paintwork
- The chain is made of specially hardened steel

## SECURITY LEVEL



## VERSIONS



blue



red



lime



pink



Ref. No.

Art. No.

EAN  
4003318

⌀  
↑  
mm

●—●  
cm

Weight  
g

Box  
Qty

Ref. No.	Art. No.	EAN 4003318	⌀ ↑ mm	●—● cm	Weight g	Box Qty
5805K/75 black	10071205-01	71205 0	5	75	590	6
5805K/75 blue	10072490-01	72490 9	5	75	590	6
5805K/75 red	10072489-01	72489 3	5	75	590	6
5805K/75 lime	10072491-01	72491 6	5	75	590	6
5805K/75 pink	10072492-01	72492 3	5	75	590	6
5805K/110 black	10072493-01	72493 0	5	110	780	6

# STEEL-O-CHAIN™ 5805C

## SECURITY LEVEL



## VERSIONS



blue



red



lime



pink



## TECHNICAL DATA

- 5 mm thick square chain with textile sleeve that prevents damage to paintwork
- The chain is made of specially hardened steel
- Two-component number reels guarantee long-term readability of the digits
- The number code can be set individually

## TECHNOLOGY

Ref. No.

Art. No.

EAN  
4003318

⌀  
↑  
mm

●—●  
cm

Weight  
g

Box  
Qty

Ref. No.	Art. No.	EAN 4003318	⌀ ↑ mm	●—● cm	Weight g	Box Qty
5805C/75 black	10071206-01	71206 7	5	75	500	6
5805C/75 blue	10072494-01	72494 7	5	75	500	6
5805C/75 red	10072495-01	72495 4	5	75	500	6
5805C/75 lime	10072496-01	72496 1	5	75	500	6
5805C/75 pink	10072497-01	72497 8	5	75	500	6
5805C/110 black	10072498-01	72498 5	5	110	720	6

# STEEL-O-CHAIN™ 4804K

## SECURITY LEVEL



## FEATURES



## VERSIONS



blue



red



lime



pink

Chain locks

## TECHNICAL DATA

- 4 mm thick square chain with textile sleeve that prevents damage to paintwork
- The chain is made of specially hardened steel

## TECHNOLOGY



Ref. No.	Art. No.	EAN 4003318	⌀ ↑ mm	●—○ cm	Weight g	Box Qty
4804K/75 black	10072483-01	72483 1	4	75	380	6
4804K/75 blue	10072484-01	72484 8	4	75	380	6
4804K/75 red	10072485-01	72485 5	4	75	380	6
4804K/75 lime	10072486-01	72486 2	4	75	380	6
4804K/75 pink	10072487-01	72487 9	4	75	380	6
4804K/110 black	10072488-01	72488 6	4	110	520	6

## STEEL-O-CHAIN™ 4804C SYMBOLS



### TECHNICAL DATA

- 4 mm square chain with fabric sleeve to prevent damage to the bicycle's paintwork
- The chain is made of specially hardened steel
- Playfully easy use for children due to symbols instead of digits
- Individually settable code

### TECHNOLOGY



### SECURITY LEVEL

### VERSIONS



symbols blue



symbols pink



symbols red

### Ref. No.

### Art. No.

EAN  
4003318



mm



cm

Weight  
g

Box  
Qty

4804C/75 blue SYMBOLS

10086809-01

86809 2

4

75

360

6

4804C/75 pink SYMBOLS

10086810-01

86810 8

4

75

360

6

4804C/75 red SYMBOLS

10087499-01

87499 4

4

75

360

6

4804C/75 lime SYMBOLS

10087498-01

87498 7

4

75

360

6

## STEEL-O-CHAIN™ 4804C



### TECHNICAL DATA

- 4 mm thick square chain with textile sleeve that prevents damage to paintwork
- The chain is made of special hardened steel
- Individually settable code

### TECHNOLOGY



### SECURITY LEVEL

### VERSIONS



blue



red



lime



pink



black

### Ref. No.

### Art. No.

EAN  
4003318



mm



cm

Weight  
g

Box  
Qty

4804C/75 black

10071617-01

71617 1

4

75

360

6

4804C/75 blue

10071616-01

71616 4

4

75

360

6

4804C/75 red

10072468-01

72468 8

4

75

360

6

4804C/75 lime

10072480-01

72480 0

4

75

360

6

4804C/75 pink

10072481-01

72481 7

4

75

360

6

4804C/110 black

10072482-01

72482 4

4

110

480

6

# 1500 WEB

## FEATURES



## TECHNICAL DATA

- 4 mm round chain with textile sleeve to protect against damage to the paintwork
- The chain is made of special steel

## TECHNOLOGY



## SECURITY LEVEL

## VERSIONS



lime



orange



coral



red

## Ref. No.

## Art. No.

EAN  
4003318

## Version



mm



cm

Weight  
g

Box  
Qty

1500/60 web black	10056345-01	56345 4		4	60	230	12
1500/60 web lime	10056344-01	56344 7		4	60	230	12
1500/60 web orange	10056920-01	56920 3		4	60	230	12
1500/60 web coral	10057895-01	57895 3		4	60	230	12
1500/60 web color	10057658-01	57658 4	4x lime, orange, red	4	60	230	12
1500/110 web black	10056346-01	56346 1		4	110	360	12
1500/110 web color	10057659-01	57659 1	4x lime, orange, red	4	110	360	12

# 1200 WEB

## SECURITY LEVEL

## VERSIONS



lime



orange



red



white



coral

## Ref. No.

## Art. No.

EAN  
4003318

## Version



mm



cm

Weight  
g

Box  
Qty

1200/60 web black	10056341-01	56341 6		4	60	200	12
1200/60 web lime	10056340-01	56340 9		4	60	200	12
1200/60 web orange	10056922-01	56922 7		4	60	200	12
1200/60 web red	10056339-01	56339 3		4	60	200	12
1200/60 web white	10056924-01	56924 1		4	60	200	12
1200/60 web coral	10057893-01	57893 9		4	60	200	12
1200/60 web color	10057656-01	57656 0	4x lime, orange, red	4	60	200	12
1200/110 web black	10056342-01	56342 3		4	110	330	12
1200/110 web color	10057657-01	57657 7	4x lime, orange, red	4	110	330	12

## TECHNICAL DATA

- 4 mm thick rounded chain with textile sleeve to prevent damage to paintwork
- The chain is made of specially hardened steel

**GOOSE LOCK**



**L O C K**

**GOOSE LOCK 6206K**



Page 70

**GOOSE LOCK 4204K**



Page 71

# GOOSE LOCK 6206K

## SECURITY LEVEL



## FEATURES



6N



## VERSIONS



black



rosemauve





flint

## TECHNICAL DATA

- 6 mm thick chain with functional, durable and highly flexible textile fibre sheathing
- Dimensionally stable and flexible chain lock with textile feel
- Soft coating provides strong protection against wear
- The chain, housing and structural parts of the locking mechanism are made of specially hardened steel

## TECHNOLOGY



Ref. No.	Art. No.	EAN 4003318	 mm	 cm	Weight g	Box Qty
6206K/85 black	10095546-01	95546 4	35	85	920	6
6206K/110 black	10095547-01	95547 1	35	110	1120	6
6206K/110 rosemauve	10096156-01	96156 4	35	110	1120	6
6206K/110 mint	10096158-01	96158 8	35	110	1120	6
6206K/110 flint	10096157-01	96157 1	35	110	1120	6

# GOOSE LOCK 4204K

## SECURITY LEVEL



## FEATURES



## VERSIONS



rosemauve



mint





flint

## TECHNICAL DATA

- 4 mm thick chain with functional, durable and highly flexible textile fibre coating
- Dimensionally stable and flexible chain lock with textile feel
- Durable coating provides strong protection against wear
- The chain is made of specially hardened steel
- Can be locked quickly and without a key

## TECHNOLOGY



Ref. No.	Art. No.	EAN 4003318			Weight g	Box Qty
			mm	cm		
4204K/85 black	10038138-01	38138 6	24	85	710	6
4204K/110 black	10038137-01	38137 9	24	110	860	6
4204K/110 rosemauve	10094401-01	94401 7	24	110	860	6
4204K/110 mint	10041022-01	41022 2	24	110	860	6
4204K/110 flint	10040674-01	40674 4	24	110	860	6

**STEEL-O-FLEX LOCKS**



**IVERA STEEL-0-FLEX™  
7200**



Page 74

**MICROFLEX 6615K**



Page 75

**TRESORFLEX 6615C**



Page 75

# IVERA STEEL- O- FLEX™ 7200

## SECURITY LEVEL



## FEATURES



Z73



Bracket IVERA RBU



Bracket UGH 02



## TECHNICAL DATA

- 22 mm thick, overlapping steel shells protect the internal steel cable
- New, functional, durable and highly flexible synthetic sleeve prevents damage to paintwork
- The steel shells, the housing and the structural parts of the locking mechanism are manufactured using specially hardened steel

## TECHNOLOGY



## TEST SEALS



Ref. No.	Art. No.	EAN 4003318	⌀ ↑ mm	●—○ cm	Weight g	Box Qty
7200/85	10055137-01	55137 6	22	85	700	6
7200/110	10055138-01	55138 3	22	110	860	6
Bracket IVERA RBU	10058497-01	58497 8			125	1
Bracket UGH 02	10026624-01	26624 9			80	66

# MICROFLEX 6615K

## FEATURES



## SECURITY LEVEL





## TECHNICAL DATA

- 15 mm thick, overlapping steel shells protect the internal steel cable
- Plastic coating to prevent damage to the bicycle's paintwork

## TECHNOLOGY



Ref. No.	Art. No.	EAN 4003318	 mm	 cm	Weight g	Box Qty
6615K/85/15 black	10013410-01	13410 4	15	85	540	6
6615K/85/15 black SCMU	10013408-01	13408 1	15	85	580	6
Bracket SCLL 6K	10087984-01	87984 5			47	12
Bracket Snap Cage MU 6K	10020079-01	20079 3			40	12

# TRESORFLEX 6615C

## FEATURES



## SECURITY LEVEL





## TECHNICAL DATA

- 15 mm thick, overlapping steel shells protect the internal steel cable
- Plastic coating to prevent damage to the bicycle's paintwork
- Two-component number reels ensure long-term readability of the digits
- Special touch protection for increased security against unauthorised access to the code through manipulation of the mechanism
- Dark-touch function facilitates use in the dark thanks to special imprinting
- Individually configurable code

## TECHNOLOGY



Ref. No.	Art. No.	EAN 4003318	 mm	 cm	Weight g	Box Qty
6615C/85/15 black	10013659-01	13659 7	15	85	560	6
6615C/85/15 black SCMU	10013657-01	13657 3	15	85	705	6
Bracket SCLL 6C	10087983-01	87983 8			47	12
Bracket Snap Cage MU 6C	10020113-01	20113 4			40	12

**COIL CABLE AND CABLE LOCKS**



**PHANTOM™  
8950**



Page 78

**BOOSTER  
6512K**



Page 79

**TRESOR  
6512C**



Page 79

**PRIMO  
5510K**



Page 80

**NUMERO  
5510C**



Page 80

**STAR  
4508K**



Page 81

**STAR  
4508C**



Page 81

**IVERA CABLE  
7220**



Page 82

**RACER  
6412K**



Page 83

**TREASOR  
6412C**



Page 83

**PRIMO  
5410K**



Page 84

**NUMERINO  
5410C**



Page 84

**3406K**



Page 85

Coil cable and  
cable locks

# PHANTOM™ 8950

## SECURITY LEVEL



## FEATURES



RH EC



Bracket KF



Bracket TexKF Mini



Bracket TexFL





## TECHNICAL DATA

- 12 or 15 mm thick, high-quality and super flexible spiral cable
- Plastic coating in matte black look to prevent damage to the bicycle's paintwork
- ABUS Extra Classe (EC) automatic cylinder with coded reversible key

## TECHNOLOGY



Ref. No.	Art. No.	EAN 4003318	 mm	 cm	Weight g	Box Qty
8950/180 KF	10039685-01	39685 4	12	180	645	6
8950/180 TexKF	10039684-01	39684 7	12	180	655	6
8950/180 TexFL	10039802-01	39802 5	15	180	665	6

## BOOSTER 6512K

### FEATURES



Bracket SCMU



### TECHNICAL DATA



- 12 mm thick, high-quality and super flexible spiral cable
- Plastic coating to prevent damage to the bicycle's paintwork

### TECHNOLOGY



### SECURITY LEVEL



Ref. No.	Art. No.	EAN 4003318	 mm	 cm	Weight g	Box Qty
6512K/180 black	10013400-01	13400 5	12	180	531	6
6512K/180 black SCMU	10013399-01	13399 2	12	180	573	6
Bracket Snap Cage MU 6K	10020079-01	20079 3			40	12

## TRESOR 6512C

### FEATURES



Bracket SCMU



### TECHNICAL DATA



- 12 mm thick, high-quality and super flexible spiral cable
- Plastic coating to prevent damage to the bicycle's paintwork
- 2-component number reels guarantee long-term readability of the digits
- Individually configurable code

### TECHNOLOGY



### SECURITY LEVEL



Ref. No.	Art. No.	EAN 4003318	 mm	 cm	Weight g	Box Qty
6512C/180 black	10013415-01	13415 9	12	180	549	6
6512C/180 black SCMU	10013414-01	13414 2	12	180	600	6
Bracket Snap Cage MU 6C	10020113-01	20113 4			40	12

# PRIMO 5510K

## FEATURES



Bracket SCMU



## TECHNICAL DATA



- 10 mm thick, high-quality and super flexible spiral cable
- Plastic coating to prevent damage to the bicycle's paintwork

## TECHNOLOGY



## SECURITY LEVEL



Ref. No.	Art. No.	EAN 4003318	 mm	 cm	Weight g	Box Qty
5510K/180 black	10014260-01	14260 4	10	180	460	6
5510K/180 black SCMU	10014245-01	14245 1	10	180	508	6
Bracket Snap Cage MU 4K/5K	10020080-01	20080 9			40	12

# NUMERO 5510C

## FEATURES



Bracket SCMU



## TECHNICAL DATA



- 10 mm thick, high-quality and super flexible spiral cable
- Plastic coating to prevent damage to the bicycle's paintwork
- Dark-touch function facilitates use in the dark thanks to special imprinting
- Two-component number reels ensure long-term readability of the digits
- Individually configurable code

## TECHNOLOGY



## SECURITY LEVEL



Ref. No.	Art. No.	EAN 4003318	 mm	 cm	Weight g	Box Qty
5510C/180 black	10016524-01	16524 5	10	180	460	6
5510C/180 black SCMU	10016523-01	16523 8	10	180	508	6
Bracket Snap Cage MU 4C/5C	10020111-01	20111 0			40	12

## STAR 4508K

### FEATURES



### TECHNICAL DATA



- 8 mm thick, high-quality and super flexible spiral cable
- Plastic coating to prevent damage to the bicycle's paintwork

### TECHNOLOGY



### SECURITY LEVEL



Ref. No.	Art. No.	EAN 4003318	 mm	 cm	Weight g	Box Qty	RRP incl. VAT €
4508K/150 black	10020016-01	20016 8	8	150	280	12	14,95

## STAR 4508C

### SECURITY LEVEL



Ref. No.	Art. No.	EAN 4003318	 mm	 cm	Weight g	Box Qty
4508C/150 black	10020019-01	20019 9	8	150	260	12



### TECHNICAL DATA

- 8 mm thick, high-quality and super flexible spiral cable
- Plastic coating to prevent damage to the bicycle's paintwork
- Dark-touch function facilitates use in the dark thanks to special imprinting
- Individually configurable code

### TECHNOLOGY



# IVERA CABLE 7220

## SECURITY LEVEL



## FEATURES



Z73



Bracket IVERA RBU



Bracket UGH 02



## TECHNICAL DATA

- 20 mm thick, high-quality steel cable
- New, functional, durable and highly flexible Ivy synthetic-fibre coating to prevent damage to the paintwork
- The body and structural parts of the locking mechanism are manufactured using specially hardened steel

## TECHNOLOGY



## TESTSIEGEL



Ref. No.	Art. No.	EAN 4003318	Cable Dimensions		Weight g	Box Qty
			mm	cm		
7220/85 black	10055145-01	55145 1	20	85	660	6
Bracket IVERA RBU	10058497-01	58497 8			125	1
Bracket UGH 02	10026624-01	26624 9			80	66

## RACER 6412K

### FEATURES



Bracket SCM U



### TECHNICAL DATA



- 12 mm thick steel cable
- Plastic coating to prevent damage to the bicycle's paintwork

### TECHNOLOGY



### SECURITY LEVEL



Ref. No.	Art. No.	EAN 4003318	 mm	 cm	Weight g	Box Qty
6412K/85 black SCM U	10040805-01	40805 2	12	85	387	6
Bracket Snap Cage MU 6K	10020079-01	20079 3			40	12

## TRESOR 6412C

### FEATURES



Bracket SCM U



### TECHNICAL DATA



- 12 mm thick steel cable
- Plastic coating to prevent damage to the bicycle's paintwork
- Two component moulded digits guarantee life-long visibility
- Individually configurable code

### TECHNOLOGY



### SECURITY LEVEL



Ref. No.	Art. No.	EAN 4003318	 mm	 cm	Weight g	Box Qty
6412C/85 black SCM U	10040808-01	40808 3	12	85	441	6
Bracket Snap Cage MU 6C	10020113-01	20113 4			40	12

# PRIMO 5410K

## FEATURES



Bracket SCMU



## TECHNICAL DATA



- 10 mm thick steel cable
- Plastic coating to prevent damage to the bicycle's paintwork

## TECHNOLOGY



## SICHERHEITSLABEL



Ref. No.	Art. No.	EAN 4003318	 mm	 cm	Weight g	Box Qty
5410K/85 black	10040798-01	40798 7	10	85	278	6
Bracket Snap Cage MU 4K/5K	10020080-01	20080 9			40	12

# NUMERINO 5410C



## TECHNICAL DATA

- 10 mm thick steel cable
- Plastic coating to prevent damage to the bicycle's paintwork
- Two component moulded digits guarantee life-long visibility
- Individually configurable code

## TECHNOLOGY



## SECURITY LEVEL



Ref. No.	Art. No.	EAN 4003318	 mm	 cm	Weight g	Box Qty
5410C/85 black	10040801-01	40801 4	10	85	276	6

# 3406K

## SECURITY LEVEL



## FEATURES



## VERSIONS



blue



orange



red



green



pink





silver

Coil cable and  
cable locks

## TECHNICAL DATA

- 6 mm thick steel cable
- Plastic coating to prevent damage to the bicycle's paintwork
- Automatic locking mechanism

Ref. No.	Art. No.	EAN 4003318	Version	 mm	 cm	Weight g	Box Qty
3406K/55 black	10040782-01	40782 6		6	55	139	12
3406K/55 color	10040785-01	40785 7	2x all colors except black	6	55	139	12

**FRAME LOCKS AND BATTERY LOCKS**



**GRANIT XPLUS™  
6950**



Page 90

**PRO AMPARO  
4750X / XL**



Page 91

**PRO AMPARO  
4750S / SL**



Page 92

**AMPARO  
4650X / XL**



Page 93

**AMPARO  
4650S / SL**



Page 93

**PRO TECTIC™  
4960**



Page 94

**TECTIC™  
496**



Page 94

**ACH SUPERIOR  
ADAPTOR CHAIN**



Page 95



**ACH CLASSIC  
ADAPTOR CHAIN**



Page 96



**IVYTEX  
ADAPTOR CHAIN**



Page 97

**ADAPTOR  
CABLE**



Page 97

# FRAME LOCKS

We want to help you find the right frame lock for your customer's bike even faster in the future. The dimensions below should help you with this.

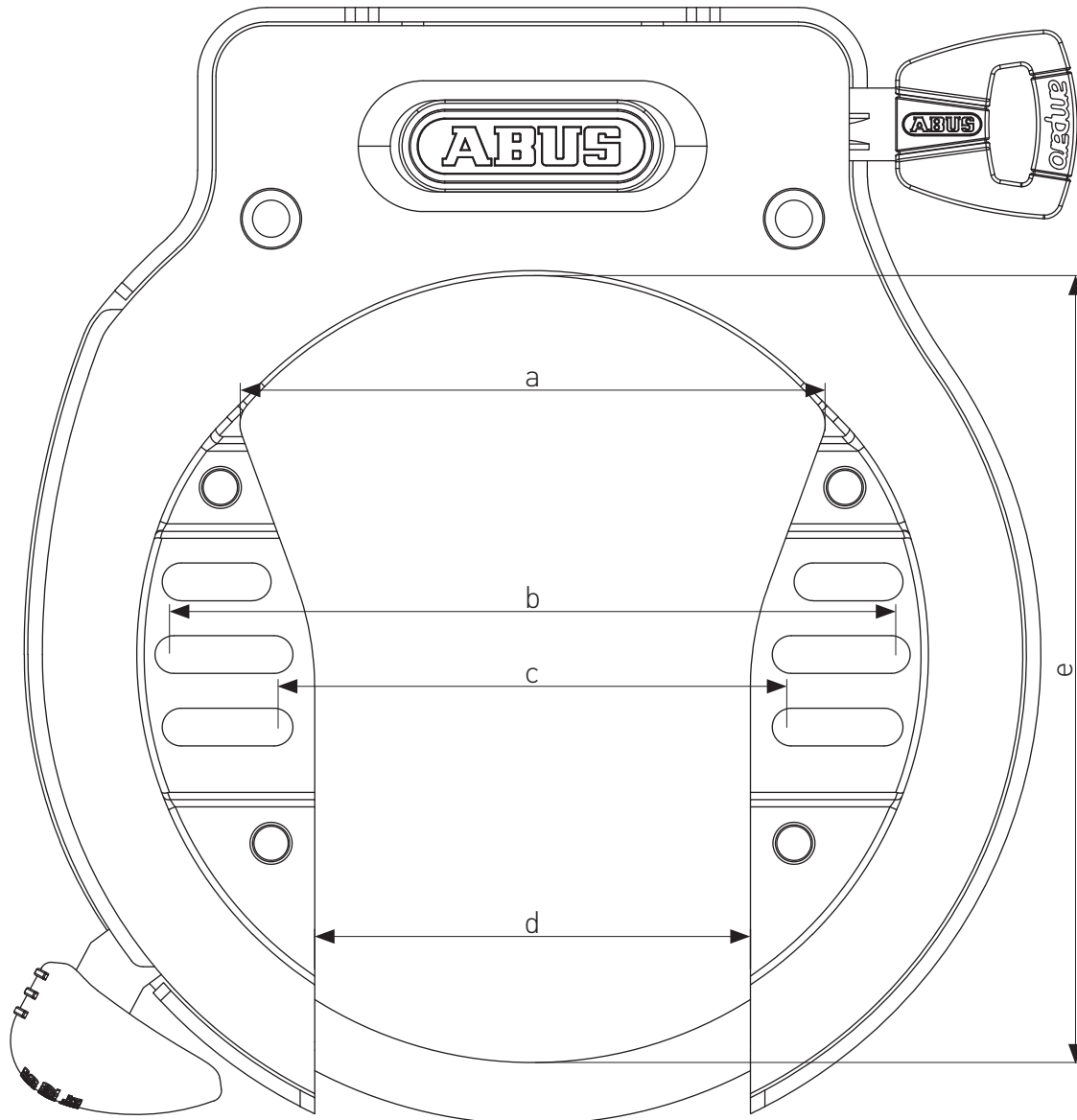

- a Maximum mudguard width
- b Maximum hole spacing of rear mounting points
- c Minimum hole spacing of rear mounting points
- d Maximum tire width
- e Maximum height clearance (top of mudguard vs rim)

You will find an overview of all dimensions on the next page. In addition, you will also find all relevant dimensions on each product page in the tables.

Ref. No.

EAN  
4003318

a  
mm

b  
mm

c  
mm

d  
mm

e  
mm

Weight  
g

Box  
Qty

# ALL FRAME LOCK DIMENSIONS IN OVERVIEW

**6950M AM**

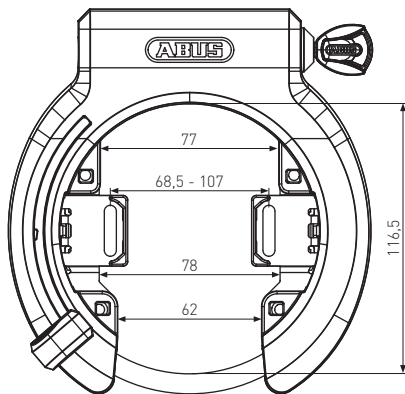

**4750X / 4750XL**

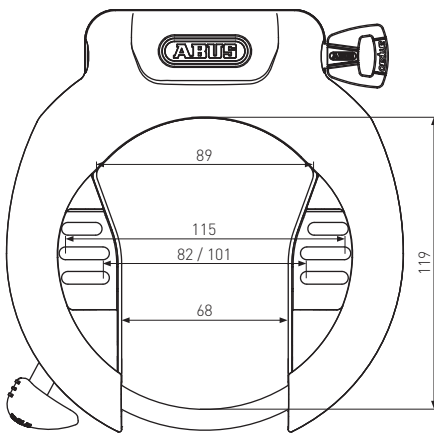

**4750S / 4750SL**

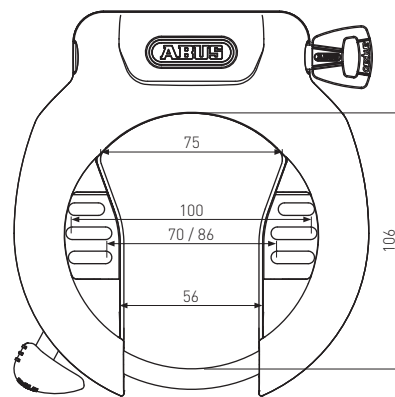

**4650X / 4650XL**

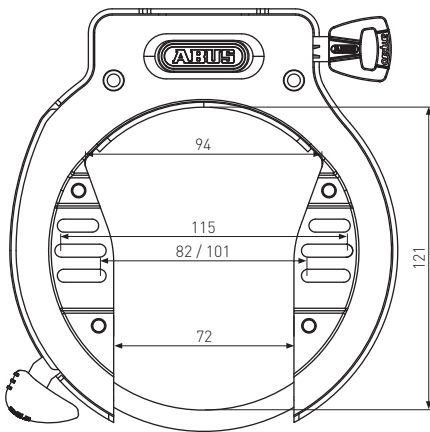

**4650S / 4650SL**

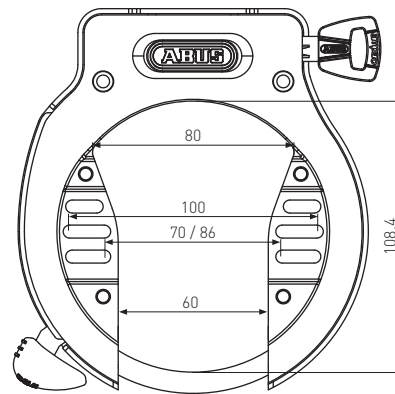

**4960**

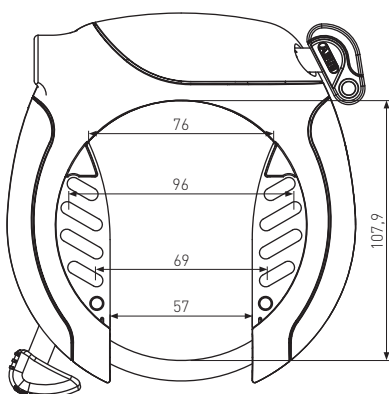

**496**

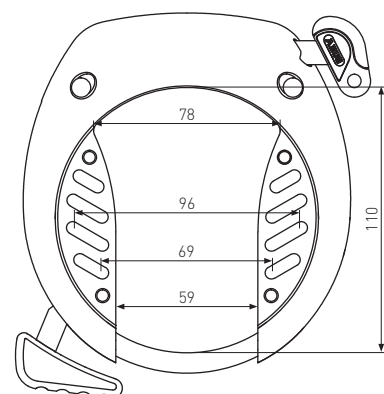

Frame locks and battery locks

All dimensions in mm.

# GRANIT XPLUS™ 6950

## SECURITY LEVEL



## FEATURES



XPlus™



All Mounting Plate



FMU 6950



Adapter plate 6950



## TECHNICAL DATA

- 8.5 mm thick locking shackle
- The shackle, housing and structural parts of the locking mechanism are made of specially hardened steel
- Closing mechanism for simple connection of accessories in the lock housing
- ABUS XPlus cylinder for the greatest protection against manipulation such as picking
- In the R variant, the key remains in the cylinder when the lock is opened; in the NR variant, it can be pulled out
- Hole spacing for mounting is universally adjustable

## TECHNOLOGY



## TEST SEALS



1) VK 38581 2) Applies only to R variants.

Ref. No.	Art. No.	EAN 4003318	a mm	b mm	c mm	d mm	e mm	Weight g	Box Qty
6950M AM R BK XPlus™	10061914-01	61914 4	77	68,5-107	78	62	116,5	770	6
6950M AM R BK XPlus™ OE	10061928-01	61928 1	77	68,5-107	78	62	116,5	770	10
6950M AM NR BK XPlus™	10061915-01	61915 1	77	68,5-107	78	62	116,5	770	6
6950M AM NR BK XPlus™ OE	10061916-01	61916 8	77	68,5-107	78	62	116,5	770	10
6950M AM NR BK XPlus™ + 6KS/85 + ST 5950	10095912-01	95912 7	77	68,5-107	78	62	116,5	1560	3
6950M AM NR BK XPlus™ + 6KS/100 + ST 5950	10095913-01	95913 4	77	68,5-107	78	62	116,5	1750	3
6950M AM NR BK XPlus™ + 6KS/130 + ST 5950	10061924-01	61924 3	77	68,5-107	78	62	116,5	1920	3
FMU 6950 2 Stück	10096201-01	96201 1						40	1
Adapter plate 6950 10 pieces	10099186-01	99186 8						40	10

# PRO AMPARO 4750 X / XL

## SECURITY LEVEL



## FEATURES



T82



SH



Mounting Straps LH



## VERSIONS



4750XL

## TECHNICAL DATA

- 8.5 mm steel shackle
- The case, the shackle as well as supporting elements of the locking mechanism are made of specially hardened steel
- Extreme large aperture for extra wide tires
- Closing mechanism for easy attachment of accessory to the lock body
- The R (key retaining) version holds the key when the lock is open, the NR (non key retaining) version allows taking the key out of the cylinder

## TECHNOLOGY



## TEST SEALS



1) XL R variants: VK 40232 2) X R variants: VK 40231 3) NR variants: VK 35482 4) Applies only to R variants.

Ref. No.	Art. No.	EAN 4003318	a mm	b mm	c mm	d mm	e mm	Weight g	Box Qty
4750X NR black PRO AMPARO	10069349-01	69349 6	89	115	82	68	119	860	12
4750X NR black OE	10086734-01	86734 7	89	115	82	68	119	860	12
4750X R black PRO AMPARO	10069352-01	69352 6	89	115	82	68	119	860	12
4750X R black OE	10086735-01	86735 4	89	115	82	68	119	860	12
4750XL NR black PRO AMPARO	10069353-01	69353 3	89	115	101	68	119	800	12
4750XL NR black OE	10086736-01	86736 1	89	115	101	68	119	800	12
4750XL R black PRO AMPARO	10069354-01	69354 0	89	115	101	68	119	800	12
4750XL R black OE	10086737-01	86737 8	89	115	101	68	119	800	12
SH485/495	10037552-01	37552 1						56	6
Mounting strap LH adaptor	10056240-01	56240 2						48	80

# PRO AMPARO 4750 S / SL

## SECURITY LEVEL



## FEATURES



T82



SH



Mounting Straps LH



## VERSIONS



4750SL

## TECHNICAL DATA

- 8.5 mm shackle
- The shackle, the housing and the locking mechanism's load-bearing parts are manufactured from specially hardened steel
- Accessories can easily be fitted to the locking mechanism on the lock housing
- In the R version, the key remains in the cylinder when the lock is opened; in the NR version, it can be pulled out

## TECHNOLOGY



## TEST SEALS



1) SL R variants: VK 40226 2) S R variants: VK 40227 3) NR variants: VK 34358 4) Applies only to R variants.

Ref. No.	Art. No.	EAN 4003318	a mm	b mm	c mm	d mm	e mm	Weight g	Box Qty
4750S NR black PRO AMPARO	10089676-01	89676 7	75	100	70	56	106	652	12
4750S NR black OE	10082611-01	82611 5	75	100	70	56	106	700	16
4750S R black PRO AMPARO	10089677-01	89677 4	75	100	70	56	106	700	12
4750S R black OE	10082612-01	82612 2	75	100	70	56	106	760	16
4750SL NR black PRO AMPARO	10089678-01	89678 1	75	100	86	56	106	740	12
4750SL NR black OE	10083573-01	83573 5	75	100	86	56	106	740	16
4750SL R black PRO AMPARO	10089679-01	89679 8	75	100	86	56	106	740	12
4750SL R black OE	10083574-01	83574 2	75	100	86	56	106	740	16
SH485/495	10037552-01	37552 1						56	6
Mounting strap LH adaptor	10056240-01	56240 2						48	80

## AMPARO 4650 X / XL

### FEATURES



T82



SH



### SECURITY LEVEL



### VERSIONS



4650XL

### TECHNICAL DATA

- 8.5 mm steel shackle
- The case, the shackle as well as supporting elements of the locking mechanism are made of specially hardened steel
- Extreme large aperture for extra wide tires
- Closing mechanism for easy attachment of accessory to the lock body
- The R (key retaining) version holds the key when the lock is open, the NR (non key retaining) version allows taking the key out of the cylinder

### TECHNOLOGY



### TEST SEALS



Ref. No.	Art. No.	EAN 4003318	a mm	b mm	c mm	d mm	e mm	Weight g	Box Qty
4650X NR black OE	10086730-01	86730 9	94	115	82	72	121	720	14
4650X R black OE	10086731-01	86731 6	94	115	82	72	121	720	14
4650XL NR black OE	10086732-01	86732 3	94	115	101	72	121	720	14
4650XL R black OE	10086733-01	86733 0	94	115	101	72	121	720	14
4650X NR black + ACH 2.0 6KS/100 + ST5950	10096992-01	96992 8	94	115	82	72	121	2125	4
SH485/495	10037552-01	37552 1						56	6
Mounting strap LH adaptor	10056240-01	56240 2						48	80

## AMPARO 4650 S / SL

### FEATURES



T82



SH



### SECURITY LEVEL



### VERSIONS



4650SL

### TECHNICAL DATA

- 8.5 mm shackle
- The shackle, the housing and the locking mechanism's load-bearing parts are manufactured from specially hardened steel
- Accessories can easily be fitted to the locking mechanism on the lock housing
- In the R version, the key remains in the cylinder when the lock is opened; in the NR version, it can be pulled out

### TECHNOLOGY



### TEST SEALS



Ref. No.	Art. No.	EAN 4003318	a mm	b mm	c mm	d mm	e mm	Weight g	Box Qty
4650S NR black OE	10082609-01	82609 2	80	100	70	60	108,4	660	20
4650S R black OE	10082610-01	82610 8	80	100	70	60	108,4	660	20
4650SL NR black OE	10083575-01	83575 9	80	100	86	60	108,4	640	20
4650SL R black OE	10083576-01	83576 6	80	100	86	60	108,4	640	20
4650SL R BK T82	10098165-01	98165 4	80	100	86	60	108,4	640	14
SH485/495	10037552-01	37552 1						56	6
Mounting strap LH adaptor	10056240-01	56240 2						48	80

# PRO TECTIC™ 4960

## FEATURES



T82



SH

## SECURITY LEVEL



## TECHNICAL DATA

- 8.5 mm thick locking shackle
- The shackle, the case as well as supporting elements of the locking mechanism are made of specially hardened steel
- Accessories can easily be fitted to the locking mechanism on the lock housing
- The R (key retaining) version holds the key when the lock is open, the NR (non key retaining) version allows taking the key out of the cylinder

## TECHNOLOGY



Ref. No.	Art. No.	EAN 4003318	a mm	b mm	c mm	d mm	e mm	Weight g	Box Qty
4960 NR black	10011260-01	11260 7	76	96	69	57	107,9	520	6
4960 NR black OE	10011270-01	11270 6	76	96	69	57	107,9	520	18
SH485/495	10037552-01	37552 1						56	6
Mounting strap LH adaptor	10056240-01	56240 2						48	80

# TECTIC™ 496

## FEATURES



T82



SH

## SECURITY LEVEL



## TECHNICAL DATA

- 8.5 mm thick locking shackle
- The shackle, the case as well as supporting elements of the locking mechanism are made of specially hardened steel
- The R (key retaining) version holds the key when the lock is open, the NR (non key retaining) version allows taking the key out of the cylinder

## TECHNOLOGY



Ref. No.	Art. No.	EAN 4003318	a mm	b mm	c mm	d mm	e mm	Weight g	Box Qty
496 NR black	10011258-01	11258 4	78	96	69	59	110	450	6
496 NR black OE	10011269-01	11269 0	78	96	69	59	110	450	24
496 R black OE	10019457-01	19457 3	78	96	69	59	110	450	24
SH485/495	10037552-01	37552 1						56	6
Mounting strap LH adaptor	10056240-01	56240 2						48	80

# ADAPTOR CHAIN SUPERIOR

## FEATURES



ST 5050



ST 5950 2.0



## VERSIONS



metal blue



bike packing green

## TECHNICAL DATA

- 7 mm thick square chain made of specially hardened steel
- Oval loop ring in a new design for optimised grip and improved feel
- Fabric coating protects against scratches and paint damage
- 360° flexibility of the loop ring
- Additional security lock for bikes with a frame lock or the Alarmbox 2.0
- The adaptor chain is locked directly in the frame lock with the locking bolt so that no separate locking with a key is necessary
- Offers flexibility when securing objects

## TECHNOLOGY



Frame locks and  
battery locks

Ref. No.	Art. No.	EAN 4003318	⌀ mm	●○○ cm	Weight g	Box Qty
ACH SUPERIOR 7KS/100 black	10047315-01	47315 9	7	only 100 cm length	1300	1
ACH SUPERIOR 7KS/100 metal blue	10047316-01	47316 6	7	only 100 cm length	1300	1
ACH SUPERIOR 7KS/100 bike packing green	10047334-01	47334 0	7	only 100 cm length	1300	1
ACH SUPERIOR 7KS/100 black + ST 5950	10047337-01	47337 1	7	only 100 cm length	1410	1
ACH SUPERIOR 7KS/130 black	10047370-01	47370 8	7	130	1662	1
ST 5050	10040992-01	40992 9			166	60
ST 5950 2.0	10087510-01	87510 6			130	48

# ADAPTOR CHAIN CLASSIC



## FEATURES





ST 5050



ST 5950 2.0

## TECHNICAL DATA

- 5.5 mm thick square chain made of hardened steel
- Oval loop ring for optimised grip and improved feel
- Fabric coating protects against scratches and paint damage
- Additional security lock for bikes with a frame lock or the Alarmbox 2.0
- The adaptor chain is locked directly in the frame lock with the locking bolt so that no separate locking with a key is necessary
- Offers flexibility when securing objects

Ref. No.	Art. No.	EAN 4003318	 mm	 cm	Weight g	Box Qty
ACH CLASSIC 5.5KS/85 black	10075655-01	75655 9	5,5	85	615	1
ACH CLASSIC 5.5KS/85 black + ST 5950	10075642-01	75642 9	5,5	85	730	1
ACH CLASSIC 5.5KS/100 black	10047293-01	47293 0	5,5	100	740	1
ACH CLASSIC 5.5KS/100 black + ST 5950	10047294-01	47294 7	5,5	100	850	1
ACH CLASSIC 5.5KS/130 black	10047295-01	47295 4	5,5	130	920	1
ACH CLASSIC 5.5KS/130 black + ST 5950	10047296-01	47296 1	5,5	130	1030	1
ACH CLASSIC 5.5KS/150 black	10047297-01	47297 8	5,5	150	1050	1
ST 5050	10040992-01	40992 9			166	60
ST 5950 2.0	10087510-01	87510 6			130	48

## ADAPTOR CHAIN IVYTEX

### FEATURES



ST5950



ST5050



### VERSIONS





8KS black

### TECHNICAL DATA

- Adapter chain with IvyTex coating
- Square profile chain made of our own hardened steel alloy
- Hydrophobic IvyTex cover repels dirt and moisture
- 6 and 8 mm square chain made of hardened steel
- Fabric coating on the loop ring to protect against damage to the paintwork
- With frame locks, there is no need to separately lock the shackle
- Various options for connecting to fixed objects or linking multiple bicycles
- Suitable for ABUS frame locks and Alarmbox 2.0

### TECHNOLOGY



Ref. No.	Art. No.	EAN 4003318	 mm	 cm	Weight g	Box Qty
ACH IVY 6KS/85 black	10068457-01	68457 9	6	85	760	6
ACH IVY 6KS/100 black	10068460-01	68460 9	6	100	860	6
ACH IVY 6KS/100 black + ST5950	10069055-01	69055 6	6	100	1064	6
ACH IVY 6KS/130 black	10068463-01	68463 0	6	130	1140	6
ACH IVY 8KS/100 black	10068466-01	68466 1	8	100	1400	4
ST 5050	10040992-01	40992 9			166	60
ST 5950 2.0	10087510-01	87510 6			130	48

## ACL ADAPTOR CABLE

### FEATURES





ST 5850



### TECHNICAL DATA

- 12 mm thick, high-quality steel cable
- Opens up a lot of opportunities for locking the bicycle on to a fixed object
- Suitable for ABUS frame locks and Alarmbox 2.0

Ref. No.	Art. No.	EAN 4003318	 mm	 cm	Weight g	Box Qty
ACL 12/100 black	10018243-01	18243 3	12	100	416	6
ST 5850/5650/4960	10048647-01	48647 0			100	1

# SERVICE PRICELIST

## BATTERY LOCKS

<b>Bafang</b>		<b>Darfon</b>	
96306	BLO BAF 15,7 T82 Service	96300	BLO DAF UNI LC T83 Service
<b>Bike Fun</b>		96513	BLO DAF UNI T82 Service
96514	BLO BFI IT1 T82 Service	96692	BLO DAF UNI T83 Service
<b>Bosch</b>		<b>Fazua</b>	
96515	BLO BOS AX1 T82 Service	96300	BLO DAF UNI LC T83 Service
96303	BLO BOS IT2.1 T82 Service	96513	BLO DAF UNI T82 Service
96281	BLO BOS DT2 T82 Service	96692	BLO DAF UNI T83 Service
96675	BLO BOS DT2 XPLUS Service	<b>Fazua</b>	
96516	BLO BOS DT3 T82 Service	96690	BLO FAZ IT2 XPLUS Service
96673	BLO BOS IT2.1 XPLUS Service	<b>Fit Biketec</b>	
96301	BLO BOS IT3 T82 Service	96681	BLO FIT IT1 XPLUS Service
96672	BLO BOS IT3 T83 Service	<b>Giant</b>	
99393	BLO BOS IT4 XPLUS Service	96504	BLO GIA IT1 F T82 Service
40455	BLO BOS DT3.1 XPLUS Service	<b>KTM</b>	
94353	BLO BOS DT3.1 T82 Service	97190	BLO KTM IT2 T82 Service
40974	BLO BOS DT3.1 XL XPLUS Service	<b>Panasonic</b>	
45980	BLO BOS IT3/IT4 Cover Service	96674	BLO PAN IT1 XPLUS Service
46267	BLO BOS DT3.2 XP Service		
46285	46285 BLO BOS DT3.2 T82 Service		
46442	BLO BOS DT3.2 XL XP Service		

**Pexco**

96565 BLO PEX IT3 PLUS Service

---

98414 BLO PEX IT3 XPLUS Service

**Phylion**

96307 BLO PHY 11,3 T82 Service

**Scott**

96680 BLO SCO IT2 auf IT2.1 Service

**Shimano**

96507 BLO SHI IT2 T82 ASY Service

---

96289 BLO SHI RT1 T82 Service

**Trek**

96509 BLO TRE IT1 T82 Service

---

**ZEG**

96576 BLO ZEG IT5 PLUS Service

---

96990 BLO ZEG IT4 XPLUS Service

---

98420 BLO ZEG IT5 XPLUS Service

**Winora**

96566 BLO+BRA WIN IT1 PLUS Service

---

99392 BLO+BRA WIN IT1 XPLUS  
Service

**IT: Intube**

**DT: Downtube**

**RT: Racktube**

\* These products will be delivered  
without individual packaging

**SPECIAL SECURITY**



**CHAIN CLAW 10**



Page 104

**ALARMBOX 2.0**



Page 105

**ALARMBOX RC**



Page 105

**WCH90**



Page 106

**GRANIT™  
WBA 100**



Page 107

**GRANIT™  
WBA 75**



Page 107

**WBA 65**



Page 108

**WBA 60**



Page 109

**WA 50**



Page 109

**SPORTFLEX 2504**



Page 110

**COMBIFLEX™**



Page 110

**COMBIFLEX™  
TRAVELGUARD**



Page 111



**COMBIFLEX™  
ADVENTURE**



Page 111

**COMBILOOP 205**



Page 112

**KETTE 6 KS LOOP**



Page 112

**COBRA™**



Page 113

**1850**



Page 113

**AFS620**



Page 114

**PS 88**



Page 114

**KEYGARAGE™  
SMART 797**



Page 115

**KEYGARAGE™  
SMART 787**



Page 115

**KEYGARAGE™  
787 BIG LED**



Page 116

**KEYGARAGE™  
787 BIG**



Page 116

**KEYGARAGE™  
797 LED**



Page 117

**KEYGARAGE™  
797**



Page 117

**KEYGARAGE™  
797 FLEX**



Page 118

**KEYGARAGE™  
767**



Page 118

**ABUS EVEROX™ ONE 61**



Page 119

**ABUS TOUCH™ 57**



Page 119

**145**



Page 121

**64 TITALIUM™**



Page 122

**70 & 70IB**



Page 123

**DISKUS®  
24IB**



Page 123

**DISKUS®  
20**



Page 124

**147TSA**



Page 124



# CHAIN CLAW 10

## SECURITY LEVEL





## TECHNICAL DATA

- 7 mm thick and 10 cm long square chain
- Rotating joints and a 55mm diameter engagement point for the cuffs provide maximum flexibility
- The chain as well as parts of the housing and clamps are made of specially hardened steel
- Opening code can be set individually

## TECHNOLOGY



Ref. No.	Art. No.	EAN 4003318	 mm	 cm	Weight g	Box Qty
Chain Claw 10 black	10095934-01	95934 9	7	10	1070	1

## ALARMBOX 2.0



### VARIANTEN



Alarmbox 2.0 black  
+ ACH 6KS/100

Alarmbox 2.0 black  
+ ACL 12/100

Ref. No.	Art. No.	EAN 4003318	Weight g	Box Qty
Alarmbox 2.0 black	10061482-01	61482 8	430	12
Alarmbox 2.0 black + ACH 6KS/100	10061488-01	61488 0	1270	6
Alarmbox 2.0 black + ACL 12/100	10061489-01	61489 7	720	6

### TECHNICAL DATA

- Alarm function with min. 100 dB for 15 seconds, followed by reactivation
- 3D Position Detection - alarm system that detects vibrations and the smallest movements in all three dimensions and triggers the alarm
- Smart alarm – the Alarmbox only emits a small warning beep in the event of minor and brief vibrations, e.g. if a football bounces nearby
- CR2 batteries included
- Mounting option on almost all round geometries
- Connection option for ABUS adapter chains and cables

### TECHNOLOGY



## ALARMBOX RC

### VERSIONS



RC



### TECHNICAL DATA

- Alarmbox with remote control
- Alarm function with min. 100 dB for 15 seconds, followed by reactivation
- 3D position detection - detects vibrations and the smallest of movements in all three dimensions and triggers an alarm
- Smart alarm – the Alarmbox only emits a small warning beep in the event of minor and brief vibrations, e.g. if a football bounces nearby
- Convenient arming and disarming by remote control
- CR2 battery included (Alarmbox) / CR2032 battery included (remote control)
- Mounting option on almost all round geometries
- Very lightweight and therefore ideal for use in sports and outdoors
- Various connection options such as cable ties, double-sided adhesive tape, Velcro, etc.

### TECHNOLOGY



Ref. No.	Art. No.	EAN 4003318	Weight g	Box Qty
Alarmbox RC SingleSet black	10061487-01	61487 3	82	12

# WCH90

## SECURITY LEVEL



## FEATURES



XPlus™



## VERSIONS



WCH90 +  
ACH 9KS/110 Twin Chain



WCH90 + ACH 9KS/130

## TECHNICAL DATA

- Wall anchor with integrated chain
- Hardened steel housing for high attack resistance
- The wall anchor is firmly anchored in the wall with special high security plugs and thus offers an extremely high level of theft protection
- The mounting plugs are included in the scope of delivery
- Only suitable for wall mounting
- The chain and the housing are made of specially hardened steel
- Textile coating to protect against paint damage
- The chains are available in different lengths
- ABUS XPlus cylinder for the greatest protection against manipulation, such as picking



Ref. No.	Art. No.	EAN 4003318	⌀ mm	●—● cm	Weight g	Box Qty
WCH90 + ACH 9KS/110	10069061-01	69061 7	9	110	3580	3
WCH90 + ACH 9KS/110 Twin Chain	10069063-01	69063 1	9	110	6620	2
WCH90 + ACH 9KS/130	10069062-01	69062 4	9	130	3960	3

## WBA100 GRANIT™

### FEATURES



### SECURITY LEVEL



### TECHNICAL DATA

- 16 mm thick shackle made of hardened special steel for maximum attack resistance
- Incl. mounting accessories



Ref. No.	Art. No.	EAN 4003318	mm	mm	mm	mm	mm	Weight g	Box Qty
WBA100 GRANIT™	10027161-01	27161 8	160	165	16	65	77	1880	13

## WBA75 GRANIT™

### FEATURES



### SECURITY LEVEL



### TECHNICAL DATA

- 14 mm thick shackle made of hardened special steel for maximum resistance
- Incl. mounting accessories



Ref. No.	Art. No.	EAN 4003318	mm	mm	mm	mm	mm	Weight g	Box Qty
WBA75 GRANIT™	10078606-01	78606 8	135	98	14	57	65	850	17

# WBA65

## FEATURES







## TECHNICAL DATA

- 10 mm thick shackle
- Holder for the rear wheel
- Simple installation without dowels
- Incl. mounting accessories

## SECURITY LEVEL



Ref. No.	Art. No.	EAN 4003318	 mm	 mm	 mm	 mm	 mm	Weight g	Box Qty
WBA65 B/SB + Bike Holder	10097167-01	97167 9	118	80	1 0	52	55	1094	10



# WBA60

## FEATURES



## TECHNICAL DATA

- 10 mm thick shackle made of hardened special steel for maximum attack resistance
- Incl. mounting accessories
- Simple installation without dowels

## SECURITY LEVEL



Ref. No.	Art. No.	EAN 4003318	mm	mm	mm	mm	mm	Weight g	Box Qty
WBA60	10082211-01	82211 7	118	80	10	52	55	450	27

# WA50

## FEATURES



## TECHNICAL DATA

- Strong wall anchor made of hardened steel
- Incl. mounting material

## SECURITY LEVEL



Ref. No.	Art. No.	EAN 4003318	mm	mm	mm	mm	mm	Weight g	Box Qty
WA50	10004294-01	04294 2	80	110	38	38	786	24	

## SPORTFLEX 2504



### TECHNICAL DATA

- Very lightweight and space-saving cable lock for mounting under the bottle holder
- Mounting by means of two screws included in the scope of delivery at the attachment points on the frame tube of the bicycle
- Low profile of 20 mm enables mounting under an existing bottle holder
- Self-retracting cable
- Opening code can be set individually
- Ideal for protection against thievery and opportunistic theft

### TECHNOLOGY



Ref. No.	Art. No.	EAN 4003318	 mm	 cm	Weight g	Box Qty
2504/90	10069054-01	69054 9	2,4	90	100	34

## COMBIFLEX™



### TECHNICAL DATA

- Self-retracting cable
- Opening code can be set and changed by the user
- Attractive pocket format fits comfortably in any pocket
- Extendible steel cable

### TECHNOLOGY



### VERSIONS





neon



midnight blue



black + CHR

Ref. No.	Art. No.	EAN 4003318	 mm	 cm	Weight g	Box Qty
Combiflex™ StopOver 65 black	10095454-01	95454 2	1,2	65	46	12
Combiflex™ StopOver 65 neon	10095458-01	95458 0	1,2	65	46	12
Combiflex™ StopOver 65 midnight blue	10095459-01	95459 7	1,2	65	46	12
Combiflex™ Break 85 black	10095455-01	95455 9	1,5	85	58	12
Combiflex™ Break 85 neon	10095460-01	95460 3	1,5	85	58	12
Combiflex™ Break 85 midnight blue	10095461-01	95461 0	1,5	85	58	12
Combiflex™ Rest 105 black	10095456-01	95456 6	2,4	105	85	12
Combiflex™ Rest 105 black + CHR	10095484-01	95484 9	2,4	105	96	12
Combiflex™ Trip 125 black	10095457-01	95457 3	3	125	128	12

## COMBIFLEX™ TRAVELGUARD



TravelGuard 70

### VERSIONS

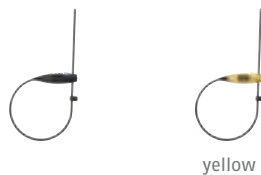

yellow

### TECHNICAL DATA

- Small and light cable protection with extra solid steel core
- Users can set and change the 3-digit code themselves
- Cable lock with releasable locking mechanism
- Safety button to prevent accidental tightening or crush injuries (70 cm variant only)

### TECHNOLOGY



Ref. No.	Art. No.	EAN 4003318	4 mm	45 cm	Weight g	Box Qty
TravelGuard black	10095468-01	95468 9	4	45	80	32
TravelGuard yellow	10095601-01	95601 0	4	45	80	32
TravelGuard red	10095600-01	95600 3	4	45	80	32
TravelGuard 70	10094792-01	94792 6	4	70	94	6

## COMBIFLEX™ ADVENTURE



### TECHNICAL DATA

- Compact cable lock with retractable cable
- Users can set and change the 3-digit code themselves
- Attractive pocket format fits comfortably in any pocket
- 4 mm thick and 75 cm long steel cable

### TECHNOLOGY



Ref. No.	Art. No.	EAN 4003318	4 mm	75 cm	Weight g	Box Qty
Combiflex™ Adventure black	10095465-01	95465 8	4	75	90	30

## COMBILoop 205



### TECHNICAL DATA

- 5 mm thick steel cable
- Synthetic coating to prevent damage to the bicycle's paintwork
- Automatic locking at insertion of the locking bolt
- Individually settable code

### SECURITY LEVEL



### TECHNOLOGY



Ref. No.	Art. No.	EAN 4003318	 mm	 cm	Weight g	Box Qty
205/200 black	10052523-01	52523 0	5	200	180	12

## CHAIN 6KS LOOP



### TECHNICAL DATA

- 6 mm-thick square chain made of hardened steel
- Diameter of loop rings: 30 mm and 50 mm
- A textile sleeve around the chain and a plastic coating on the 50 mm ring protect against paint damage
- Available in two lengths: 100 cm and 140 cm

Ref. No.	Art. No.	EAN 4003318	 mm	 cm	Weight g	Box Qty
6KS100 Loop	10097023-01	97023 8	6	100	860	6
6KS140 Loop	10097024-01	97024 5	6	140	1220	4

# COBRA™



## TECHNICAL DATA

- High quality steel cable with two loop ends
- Synthetic coating to prevent damage to the bicycle's paintwork

## VERSIONS

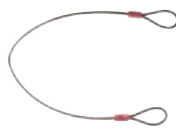

Cobra™ 5/75



Cobra™ 10/200



Cobra™ 10/500





Cobra™ 10/1000

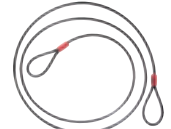

Cobra™ 12/120



Cobra™ 12/180 black

Ref. No.	Art. No.	EAN 4003318	 mm	 cm	Weight g	Box Qty
Cobra™ 5/75 black	10037106-01	37106 6	5	75	75	100
Cobra™ 8/200 black	10025718-01	25718 6	8	200	280	24
Cobra™ 8/250 black	10027390-01	27390 2	8	250	395	16
Cobra™ 10/140 black	10037107-01	37107 3	10	140	310	30
Cobra™ 10/200 black	10011167-01	11167 9	10	200	400	28
Cobra™ 10/220 black	10037108-01	37108 0	10	220	420	24
Cobra™ 10/300 black	10059930-01	59930 9	10	300	560	21
Cobra™ 10/500 black	10020780-01	20780 8	10	500	850	15
Cobra™ 10/1000 black	10020781-01	20781 5	10	1000	1580	9
Cobra™ 12/120 black	10025719-01	25719 3	12	120	380	15
Cobra™ 12/180 black	10027391-01	27391 9	12	180	490	15

# 1850



## TECHNICAL DATA

- High quality steel cable with two loop ends
- Synthetic coating to prevent damage to the bicycle's paintwork

Ref. No.	Art. No.	EAN 4003318	 mm	 cm	Weight g	Box Qty
1850/185	10012752-01	12752 6	8	185	280	18

## FIRE STOP AFS625



### TECHNOLOGY

- 625 ml highly effective foam extinguishing agent
- Easy to use – just like a conventional spray can
- Spraying range (max. distance between source of fire and user) up to 4 m
- Spray time approx. 25 seconds
- Weight: approx. 900 g gross
- Shelf life: 39 months
- Suitable for fighting incipient fires of fire classes A, B and F
- Fire class 5A: solid and non-melting substances
- Fire class 21B: liquid and melting substances
- Fire class 15F: cooking fats and cooking oils
- Also for use with electrical systems of up to 1000 V (distance of at least 1 m)

### ACCESSORIES



Bracket AFS625/FLS580

Ref. No.	Art. No.	EAN 4003318	Weight g	Box Qty
AFS625	10085727-01	85727 0	847	6
Bracket AFS625/FLS580	10056249-01	56249 5	81	1

## PS88



- Free from chlorine, fluorine (CKW/FCKW), PCB, lead and other contaminants
- Non-greasy special lubricant spray
- Door cylinders, bicycle lock cylinders, padlock cylinders, car locks, tools, sports equipment, office machines



Ref. No.	Art. No.	EAN 4003318	Version	Weight g	Box Qty
PS88 50ml D	10000117-01	00117 8	50 ml aerosol can	59	1
PS88 125ml D	10007010-01	07010 5	125 ml aerosol can	124	1
PS88 300ml D	10084408-01	84408 9	300 ml aerosol can	301	1
Display PS88 50ml D	10008217-01	08217 7	24 x 50 ml	60	6
Display PS88 125ml D	10006952-01	06952 9	12 x 125 ml	124	5
Display PS88 300ml D	10084409-01	84409 6	12 x 300 ml	3900	3

## 797 KEYGARAGE™ ONE



### TECHNOLOGY



### TECHNICAL DATA

- Sturdy metal housing provides secure storage space for keys and valuables
- Up to 20 keys, up to 3 car keys or 30 plastic cards fit in the key box compartment
- There are 2 hooks for hanging keys or key rings
- Smart operation and management of the KEYGARAGE with the free HomeTec Pro Bluetooth or ABUS One apps
- Overview of key box use in the app's clear event log
- Automatic locking after the compartment is closed
- Illuminated keypad for convenient input of the numeric code in the dark
- LED for status indication (unlocked, locked, incorrect PIN and low battery)
- Battery compartment for 2 x AA batteries, accessible from the outside
- For secure storage of keys or small valuable objects for authorised persons
- Quick and easy access for frequently changing groups of people (e.g. tradespeople, service staff, holiday guests, vehicle hire customers, care service)
- Share access via an individual six-digit numeric code or by invitation to a smartphone
- Mounting with shackle for flexible and temporary use indoors or in protected outdoor areas (e.g. on door knobs, railings or handles)
- Storage of whole key rings possible thanks to the large internal compartment
- Real-time remote access to all functions such as unlocking, locking, viewing event logs and managing access permissions via the separately available BRIDGE One.

Ref. No.

Art. No.

EAN  
4003318



mm



mm



mm

Weight  
g

Box  
Qty

797 KEYGARAGE™ One with shackle

10063825-01

63825 1

82,5

63

179

888

18

## 787 KEYGARAGE™ ONE



### TECHNOLOGY



### TECHNICAL DATA

- Secure storage of keys and small valuables in a sturdy metal housing
- Up to 20 keys, up to 3 car keys or 30 plastic cards fit in the key box compartment
- There are 2 hooks for hanging keys or key rings
- Smart operation and management of the KEYGARAGE with the free HomeTec Pro Bluetooth or ABUS One apps
- Overview of key box use in the app's clear event log
- Automatic locking after the compartment is closed
- Illuminated keypad for optimal input of the numerical code in the dark
- LED for status indication (unlocked, locked, incorrect PIN and low battery)
- Battery compartment for 2 x AA batteries, accessible from the outside
- For secure storage of keys or small valuable objects for authorised persons
- Quick and easy access for frequently changing groups of people (e.g. tradespeople, service staff, holiday guests, vehicle hire customers, care service)
- Share access via an individual 6-digit numeric code or by invitation to a smartphone
- For wall mounting indoors and in protected outdoor areas
- Storage of whole key rings possible thanks to the large internal compartment
- Real-time remote access to all functions such as unlocking, locking, viewing event logs and managing access permissions via the separately available BRIDGE One.

Ref. No.

Art. No.

EAN  
4003318



mm



mm



mm

Weight  
g

Box  
Qty

787 KEYGARAGE™  
One wall mounting

10063824-01

63824 4

82,5

63

120

883

18

## 787 LED KEYGARAGE™





### TECHNOLOGY



### TECHNICAL DATA

- Solid metal housing
- Locking cover made of zinc die-cast
- 4-digit individually settable code
- Illuminated dials for a better legibility in dark conditions
- LEDs light up ca. 30 seconds
- Customary coin cell battery (CR2032) can be easily replaced, durability of battery when used 1x per day approximately 2 years
- Protective cover with sliding mechanism
- For wall mounting with screws
- Can hold up to 20 keys or 14 code cards (787 LED) or up to 30 keys or 50 code cards (787 BIG LED)
- Easily removable clip-in hooks guarantee consumer's comfort
- Outer dimensions of housing: 84 x 120 x 42 (787 LED) / 84 x 120 x 62 (787 BIG LED)
- Ideal protected storage of keys and other valuables for authorised persons
- Quick and easy access for frequently changing groups of persons (craftsmen, service, holiday guests, apartment buildings, car rentals)
- Defining access by setting and passing on the code
- For wall mounting indoors and in protected outdoor areas

Ref. No.	Art. No.	EAN 4003318	 mm	 mm	 mm	Weight g	Box Qty
787 BIG LED wall mounting	10083856-01	83856 9	84	62	120	721	4
787 LED wall mounting	10083854-01	83854 5	84	42	120	698	1

## 787 KEYGARAGE™ BIG





### TECHNOLOGY



### TECHNICAL DATA

- Very large solid metal housing and extra large storage compartment
- Locking cover made from zinc die-cast
- Individually resettable code (4-digit)
- Protective cover with sliding mechanism
- For wall mounting with screws
- Holds up to 30 cards or 38 keys
- Easily removable clip-in hooks guarantee consumer's comfort
- Flat inner mechanism makes a larger storage space possible
- Outer dimensions of housing: 84 x 120 x 62
- Ideal protected storage of keys and other valuables for authorised persons
- Quick and easy access for frequently changing groups of persons (craftsmen, service, holiday guests, apartment buildings, car rentals)
- Defining access by setting and passing on the code
- For wall fixing indoors and in protected outdoor areas
- Storage of a complete bunch of key now possible because of larger space and removable hook

Ref. No.	Art. No.	EAN 4003318	 mm	 mm	 mm	Weight g	Box Qty
787 BIG wall mounting	10008492-01	08492 8	83,5	62	120,5	801	12
787 wall mounting	10004633-01	46331 0	80	45	120	690	1

## 797 LED KEYGARAGE™



### FEATURES





Adaptor for car window

### TECHNOLOGY



### TECHNICAL DATA

- Solid metal housing
- Locking cover made of zinc die-cast
- 4-digit individually settable code 4-digit
- Illuminated dials for a better legibility in dark conditions
- LEDs light up ca. 30 seconds
- Customary coin cell battery (CR2032) can be easily replaced, durability of battery when used 1x per day approximately 2 years
- Protective cover with sliding mechanism
- Fixing with shackle, e.g. on a door knob of gates and doors
- Can hold up to 20 keys or 14 code cards
- Outer dimensions of housing: 84 x 119 x 44
- Housing and shackle plastic coated (protects door from scratching)
- Ideal protected storage of keys and other valuables for authorised persons
- Quick and easy access for frequently changing groups of persons (craftsmen, service, holiday guests, apartment buildings, car rentals)
- Defining access by setting and passing on the code
- Fixing with shackle, e.g. on a door knob of gates and doors

Ref. No.	Art. No.	EAN 4003318	 mm	 mm	 mm	Weight g	Box Qty
797 LED with shackle	10083855-01	83855 2	84	44	120	779	8
Adaptor KeyGarage™ 777 + 797	10056321-01	56321 8	70	74	63	114	30

## 797 KEYGARAGE™



### FEATURES





Adaptor for car window

### TECHNOLOGY



### TECHNICAL DATA

- Solid metal housing
- Locking cover made of zinc die-cast
- 4-digit individually settable code
- Protective cover with sliding mechanism
- Fixing with shackle, e.g. on a door knob of gates and doors
- Can hold up to 20 keys or 14 code cards
- Outer dimensions of housing: 85 x 120 x 45
- Housing and shackle plastic coated (protects door from scratching)
- Ideal protected storage of keys and other valuables for authorised persons
- Quick and easy access for frequently changing groups of persons (craftsmen, service, holiday guests, apartment buildings, car rentals)
- Defining access by setting and passing on the code
- Fixing with shackle, e.g. on a door knob of gates and doors

Ref. No.	Art. No.	EAN 4003318	 mm	 mm	 mm	Weight g	Box Qty
797 with shackle	10046330-01	46330 3	85	45	180	800	18
Adaptor KeyGarage™ 777 + 797	10056321-01	56321 8	70	74	63	114	30

## 797 FLEX KEYGARAGE™



### TECHNOLOGY



### TECHNICAL DATA

- Large, sturdy metal housing for secure storage of keys and plastic cards
- Zinc die-cast locking flap with number wheels
- Individually adjustable 4-digit code
- Protective flap with sliding mechanism
- 10 mm thick, plastic-coated steel cable for attachment
- Attachment to objects with a circumference of up to 50 cm or up to 20 cm away from the KeyGarage
- Capacity for up to 14 plastic cards or 20 keys
- External dimensions: 84 x 340 x 44 mm
- For secure storage of keys or small valuable objects for authorised persons
- Quick and easy access for frequently changing groups of people (e.g. tradesmen, service staff, holiday guests, vehicle rental customers, residents of apartment buildings)
- Accessible by setting and sharing a number code
- Mounting with flexible cable for adaptable and temporary use, e.g. on fences, railings or handles

Ref. No.	Art. No.	EAN 4003318	 mm	 mm	 mm	Weight g	Box Qty
797 FLEX with cable	10041990-01	41990 4	84	44	340	750	12

## 767 KEYGARAGE™





### TECHNOLOGY



### TECHNICAL DATA

- Solid metal housing
- Locking cover made from zinc die-cast
- Code up to 10 digits individually resettable (the sequence of the code is irrelevant)
- Code needs to be entered in order to close the locking cover
- Plastic cover to protect against dust, dirt, etc.
- For wall fixing with screws
- Holds up to 17 cards or 20 keys
- Outer dimensions of housing: 84 x 119 x 47
- Ideal protected storage of keys and other valuables for authorised persons
- Quick and easy access for frequently changing groups of persons (craftsmen, service, holiday guests, apartment buildings, car rentals)
- Defining access by setting and passing on the code
- For wall fixing indoors and in protected outdoor areas







Ref. No.	Art. No.	EAN 4003318	 mm	 mm	 mm	Weight g	Box Qty
767 wall mounting	10053507-01	53507 9	80	45	120	697	8

## EVEROX™ ONE 61



### TECHNICAL DATA

- Lock body made of coated die-cast zinc
- IP certification IP66 & IP68 (dustproof and protected against water jets and short-term submersion)
- Hardened Nano Protect™ shackle
- Bluetooth® standard V5.2 (downwardly compatible to 4.0)
- Free ABUS One app for smart operation
- CR2 battery included
- Double bolted locking mechanism
- Automatic locking
- Spring-loaded shackle for automatic opening
- For securing medium-value items when there is a medium theft risk
- Use in conjunction with smart device and ABUS One app
- Suitable for indoor and outdoor use







Ref. No.	Art. No.	EAN 4003318	 mm	 mm	 mm	 mm	 mm	 mm	Weight g	Box Qty
EVEROX™ One 61/45	10099191-01	99191 2	45	20	30	6,5	23	95	310	24
EVEROX™ One 61/50	10099192-01	99192 9	50	24	36	8	23	103	380	24

## ABUS TOUCH™ 57



### TECHNICAL DATA

- Lock body made of coated zinc die cast
- Hardened Nano Protect™ shackle
- CR2 battery
- Capacitive sensor with minutiae detection
- 20 fingerprints can be stored
- Double ball locking
- Automatic locking
- Spring-loaded shackle for automatic opening
- IP certification IP66 & IP68
- For securing medium-value items when there is a medium risk of theft
- Use in clean areas with good fingerprint recognition
- Suitable for indoor and outdoor use

Ref. No.	Art. No.	EAN 4003318	 mm	 mm	 mm	 mm	 mm	 mm	Weight g	Box Qty
57/45 Touch™	10062575-01	62575 6	45	20	30	6,5	23	95	318	24
57/50 Touch™	10062581-01	62581 7	50	24	36	8	23	103	390	24





## TECHNICAL DATA

- Solid aluminium lock body with anodized coating – corrosion resistant
- Spring loaded shackle for a better setting of the opening code
- 145/20 and 145/30: Individually resettable 3-digit code
- 145/40: Individually resettable 4-digit code
- Handy operation without key, low weight
- High value of recognition by intensive colours
- 145/20 and 145/30: To secure valuables/goods of lesser value or at a low risk of theft
- 145/40: To secure valuables/goods of medium value or at an average risk of theft
- E.g. to secure luggage, lockers in schools and sports centres, cash boxes, jewel cases, cupboards, tool boxes, switchboards, etc.

## VERSIONS

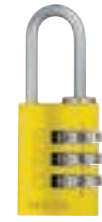

145/20 yellow



145/20 orange



145/20 red



145/20 purple



145/20 blue



145/20 green



145/20 silver



145/20 titanium

Ref. No.	Art. No.	EAN 4003318							Weight g	Box Qty
			mm	mm	mm	mm	mm	mm		
145/20 yellow B/DFNLI	10046552-01	46552 9	22,5	9	22	3	13,5	52,5	25	6
145/20 orange B/DFNLI	10046550-01	46550 5	22,5	9	22	3	13,5	52,5	23	6
145/20 red B/DFNLI	10046549-01	46549 9	22,5	9	22	3	13,5	52,5	25	6
145/20 purple B/DFNLI	10046553-01	46553 6	22,5	9	22	3	13,5	52,5	25	6
145/20 blue B/DFNLI	10046548-01	46548 2	22,5	9	22	3	13,5	52,5	23	6
145/20 green B/DFNLI	10046551-01	46551 2	22,5	9	22	3	13,5	52,5	25	6
145/20 silver B/DFNLI	10046554-01	46554 3	22,5	9	22	3	13,5	52,5	25	6
145/20 titanium B/DFNLI	10046556-01	46556 7	22,5	9	22	3	13,5	52,5	23	6
145/20 black B/DFNLI	10034609-01	34609 5	22,5	9	22	3	13,5	52,5	23	6
145/30 yellow B/DFNLI	10046561-01	46561 1	31,5	14	25	5	15,5	65	52	6
145/30 orange B/DFNLI	10046559-01	46559 8	31,5	14	25	5	15,5	65	52	6
145/30 red B/DFNLI	10046558-01	46558 1	31,5	14	25	5	15,5	65	52	6
145/30 purple B/DFNLI	10046562-01	46562 8	31,5	14	25	5	15,5	65	52	6
145/30 blue B/DFNLI	10046557-01	46557 4	31,5	14	25	5	15,5	65	52	6
145/30 green B/DFNLI	10046560-01	46560 4	31,5	14	25	5	15,5	65	52	6
145/30 silver B/DFNLI	10046563-01	46563 5	31,5	14	25	5	15,5	65	52	6
145/30 titanium B/DFNLI	10046565-01	46565 9	31,5	14	25	5	15,5	65	52	6
145/30 black B/DFNLI	10034610-01	34610 1	31,5	14	25	5	15,5	65	52	6
145/40 yellow B/DFNLI	10049534-01	49534 2	41,5	21,5	26	6	17,5	77	105	6
145/40 orange B/DFNLI	10049526-01	49526 7	41,5	21,5	26	6	17,5	77	103	6
145/40 red B/DFNLI	10048830-01	48830 6	41,5	21,5	26	6	17,5	77	110	6
145/40 blue B/DFNLI	10049522-01	49522 9	41,5	21,5	26	6	17,5	77	105	6
145/40 green B/DFNLI	10049530-01	49530 4	41,5	21,5	26	6	17,5	77	105	6
145/40 silver B/DFNLI	10049542-01	49542 7	41,5	21,5	26	6	17,5	77	105	6
145/40 titanium B/DFNLI	10049550-01	49550 2	41,5	21,5	26	6	17,5	77	105	6

# 64 TITALIUM™



## TECHNICAL DATA

- Solid lock body made from TITALIUM™ special aluminium
- Hardened steel shackle with NANO PROTECT™ coating for extreme corrosion resistance
- 64TI/50HB60-150: Removable and adjustable shackle from 60 mm to 150 mm
- Paracentric key profile for increased protection against manipulation
- Double bolted shackle
- Chrome-plated cylinder plug for additional corrosion protection
- Tulip-shaped key head
- Security for items/goods of medium value or where there is an average risk of theft
- For securing e.g. chains, doors, gates, cupboards, lockers, tool boxes, cellar windows or sheds

## VERSIONS



64TI/20 B/DFNLI



64TI/25 B/DFNLI



64TI/30 B/DFNLI



64TI/35 B/DFNLI



64TI/40HB40 B/DFNLI









64TI/40HB63 B/DFNLI



64TI/45 B/DFNLI



64TI/50 B/DFNLI

Ref. No.	Art. No.	EAN 4003318	 mm	 mm	 mm	 mm	 mm	 mm	 mm	Weight g	Box Qty
64TI/20 B/DFNLI	10056384-01	56384 3	20	9,5	11,5	3,5	10,5	34	22	6	
64TI/25 B/DFNLI	10056386-01	56386 7	24,5	13	13,5	4	12	42	31	6	
64TI/30 B/DFNLI	10056387-01	56387 4	30	16	17	5	13	50	54	6	
64TI/30HB60 B/DFNLI	10056388-01	56388 1	30	16	60	5	13	93	66	6	
64TI/35 B/DFNLI	10056390-01	56390 4	35	19	20	5,5	14	54	67	6	
64TI/40 B/DFNLI	10056391-01	56391 1	40	22	23	6	15	62	88	6	
64TI/40HB40 B/DFNLI	10056392-01	56392 8	40	22	40	6	15	79	96	6	
64TI/40HB63 B/DFNLI	10056393-01	56393 5	40	22	63	6	15	102	107	6	
64TI/45 B/DFNLI	10056398-01	56398 0	45	25	24	7	15	68	110	6	
64TI/50 B/DFNLI	10056399-01	56399 7	50	28	29	8	17	77	159	6	
64TI/50HB80 B/DFNLI	10056400-01	56400 0	50	28	80	8	17	128	199	6	
64TI/50HB60-150 B/DFNLI	10089490-01	89490 9	50	28	60-150	8	17	77	281	4	
64TI/50HB60-150 gl	10063308-01	63308 9	50	28	60-150	8	17	77	281	3	
64TI/60 B/DFNLI	10056401-01	56401 7	60	34	35	10	19	91	234	4	

## 70 EXPEDITION



### FEATURE



### TECHNICAL DATA

- Solid lock body made from brass
- Shackle made from hardened steel with plastic sleeve
- Sealed lock body with special protective cap and drainage channels to protect the locking mechanism from water and dirt
- Shock-absorbing plastic casing protects sensitive surfaces
- Double bolted
- Precision pin cylinder
- Paracentric key profile for increased protection against manipulation
- Inner components made from rust-free materials
- Self-locking: lock without the key by pushing down the shackle
- Security for items/goods of medium value or where there is an average risk of theft
- For securing chains, doors, gates, cupboards, lockers, tool boxes, cellar windows, sheds, switch boxes, etc.
- Also suitable for outdoor use

Ref. No.	Art. No.	EAN 4003318	mm	mm	mm	mm	mm	mm	mm	Weight g	Box Qty
70I/45 B/DFNLI	10032130-01	32130 6	49	20	24	8	27,5	74	179	6	
70I/45HB63 B/DFNLI	10032131-01	32131 3	49	20	63	8	27,5	112	201	6	
70IB/45 B/DFNLI	10032132-01	32132 0	49	20	24	8	27,5	74	179	6	
70IB/45HB63 B/DFNLI	10035834-01	35834 0	49	20	63	8	27,5	112	200	6	
70IB/50 B/DFNLI	10042733-01	42733 6	55	23,5	27,5	9	31	81,5	233	6	

## 24IB DISKUS®



### FEATURE



### TECHNICAL DATA

- Lock body, inner parts and shackle made solely from stainless steel for extreme resistance to corrosion
- Cylinder cover – maximum protection against dirt and water spray (60 mm and 70 mm only)
- Nickel-plated cylinder for enhanced weather protection
- Original Diskus® design: 360° protection
- Diskus® Deep-Welding Technology – the best in break-in protection
- Precision pin cylinder
- Key retaining: locking only with the key (key cannot be removed while the lock remains open)
- Made in Germany
- For the protection of larger assets and objects with a high risk of theft
- Ideal for severe weather conditions (e.g., in sea and port areas, for securing vehicles and boats in outdoor use)
- For securing trucks, doors, gates, barns, cellars, cupboards, etc.

Ref. No.	Art. No.	EAN 4003318	mm	mm	mm	mm	mm	mm	mm	Weight g	Box Qty
24IB/50 B/DFNLI	10032123-01	32123 8	51	13	8	6,5	25,5	50	143	3	
24IB/60 B/DFNLI	10035042-01	35042 9	60	17	13	8	26	60	195	6	
24IB/70 B/DFNLI	10032124-01	32124 5	70	20	17	10	31	70	295	6	

## 20 DISKUS®



### FEATURE









Plus

### TECHNOLOGY



### TECHNICAL DATA

- Stainless steel - outside and inside
- Additional protection against sawing
- Shackle made from high quality stainless steel
- ABUS-Plus disc cylinder: highest protection against manipulation, extremely high number of key differs
- Cylinder cover – maximum protection against dirt and water spray
- Sophisticated Diskus® welded seam for highest break resistance
- Original Diskus® design: 360° protection
- Key retaining: key is needed for locking (lock retains key until locked)
- SZP: comes with security card to protect against unauthorized key duplicates
- Made in Germany
- 2 keys
- To secure valuables/goods of great value or at a very high risk of theft
- To secure e.g. warehouses, industrial sites, factory gates, containers and lorries
- Ideally used with ABUS Diskus® Hasp 140: virtually impossible to attack shackle

Ref. No.	Art. No.	EAN 4003318	 mm	 mm	 mm	 mm	 mm	 mm	Weight g	Box Qty
20/70 vs.	10008854-01	08854 4	70	20	17	10	30,5	70	306	6
20/80 vs.	10008798-01	08798 1	80	25	18	11	35,5	81	416	3
20/70 B/DFNLI	10035023-01	35023 8	70	20	17	10	30,5	70	308	3
20/80 B/DFNLI	10035024-01	35024 5	80	25	18	11	35,5	81	418	3

## 147TSA









### TECHNOLOGY



### TECHNICAL DATA

- Lock body made from plastic
- Shackle diameter 3 mm
- Individually resettable 3-digit code
- Visible red indicator at shackle: lock was opened by TSA. To reset red indicator open lock and turn shackle by 360°
- Para repor o indicador para uma nova viagem, rodar o arco 360°
- Using this Travel Sentry® Approved lock allows your luggage to be opened, inspected and relocked by security authorities without damage. For more information, visit: [www.travelsentry.org](http://www.travelsentry.org)
- To secure valuables/goods of lower value or at a low risk of theft
- Suitable e.g. to secure luggage
- Ideal for journeys to the USA: the luggage can be opened/relocked by the US security authorities without damaging the lock

Ref. No.	Art. No.	EAN 4003318	 mm	 mm	 mm	 mm	 mm	 mm	Weight g	Box Qty
147TSA/30 B	10053093-01	53093 7	33	13	20	3	14	60	30	12



3

**BRACKETS AND BAGS**



**BRACKET  
SH B**



Page 129

**BRACKET  
USKF**



Page 129

**BRACKET  
EAZY KF™**



Page 129

**BRACKET USH 540 /  
470 / 460**



Page 130

**BRACKET  
GH 50**



Page 130

**BRACKET  
UGH 02**



Page 130

**SHACKLE CLAMP**



Page 131

**BRACKET  
SADDLEFIX SH SF**



Page 131

**BRACKET  
SH 6500A ONE**



Page 131

**BRACKET  
SH 6500K BORDO™**



Page 132

**BRACKET  
SH 6500 BORDO XPLUS™**



Page 132

**BRACKET  
SH 6200K**



Page 132

**BRACKET  
SH 6000 BORDO™**



Page 133

**BRACKET  
SH ML-BORDO MOUNT**



Page 133

**BRACKET  
SH 6000 BORDO™ BIG**



Page 133

**BRACKET  
SH 5700 BORDO™**



Page 134

**BRACKET SH 5700  
UGRIP BORDO™ BIG**



Page 134

**BRACKET  
SR 6055 BORDO™ LITE**



Page 134

**BRACKET  
SH 6055 SELLE ROYAL**



Page 135

**BRACKET  
ST 6000 BORDO™**



Page 135

**BRACKET ST 6000  
BORDO™ BIG**



Page 135

**BRACKET ST 5700  
UGRIP BORDO™**



Page 136

**BRACKET  
IVERA RBU**



Page 136

**BRACKET  
SNAP CAGE**



Page 137

**BRACKET  
SCLL**



Page 137

**BRACKET  
FIDLOCK FL**



Page 137

**BRACKET  
TEXKF MINI**



Page 138

**BRACKET  
FMU 6950**



Page 138

**MOUNTING STRAP**



Page 138

**ST 5950 2.0**



from Page 139

## BRACKET SH B



### TECHNICAL DATA

- Universal shackle lock holder for many ABUS U-locks
- The holder is suitable for U-locks with a 14 mm square as well as a 16 mm round shackle
- Allows the lock to be transported to different places on the bike
- The holder allows for vertical or horizontal attachment to the frame
- Suitable for U-locks 640, 540, 470, 460
- Fast and intuitive handling
- Suitable for frame diameters from 20-55 mm
- Universal bracket for the use of various U-locks

Ref. No.	Art. No.	EAN 4003318	Version	Weight g	Carrier	Box Qty
Bracket SH B	10067899-01	67899 8		150	for 640, 540, 470, 460	1

## BRACKET USKF



### TECHNICAL DATA

- Transport of U-shackle locks
- Mounting on round frames with a diameter of 18-70 mm
- Plastic bracket with rubber inlays for best mounting
- Comfortable one-hand-operation
- Easy and quick mounting
- Suitable for the shackle clamp

Ref. No.	Art. No.	EAN 4003318	Version	Weight g	Carrier	Box Qty
Bracket USKF	10086143-01	86143 7		65	for 64/46/47/770A/540/460/470/640	1

## BRACKET EAZY KF™



### TECHNICAL DATA

- Transport of U-shackle locks
- Mounting on round frames with a diameter of 28 - 36 mm
- Screws in two lengths included
- Plastic bracket for mounting with rubber inlays for best hold
- Index marks on the bracket to simplify subsequent mountings
- Comfortable one-hand-operation
- Very quick mounting
- Patented design

Ref. No.	Art. No.	EAN 4003318	Version	Weight g	Carrier	Box Qty
Bracket EaZy KF™	10045342-01	45342 7		95	for 64/61/54/51/47/540/470	50
Shackle Clamp 11 mm	10045344-01	45344 1	Ø 11 mm	22	for 61/64 EaZy KF	1
Shackle Clamp 12 mm	10045347-01	45347 2	Ø 12 mm	24	for 460/470	1
Shackle Clamp 13 mm	10045343-01	45343 4	Ø 13 mm	26	for 540	1

## BRACKET USH540 / 470 / 460



### TECHNICAL DATA

- Transport of U-shackle locks
- Mounting on round frames with a diameter of 15 - 35 mm
- Plastic bracket for mounting
- Mounting within the frame or at the side possible

Ref. No.	Art. No.	EAN 4003318	Version	Weight g	Carrier	Box Qty
Bracket USH 540	10018576-01	18576 2		150	for 540	18
Bracket USH 460 / 470	10018578-01	18578 6		120	for 460 / 470	18

## BRACKET GH 50



### TECHNICAL DATA

- Transport of round U-shackle locks with a diameter up to 17 mm
- Mounting on the side of the rack
- Plastic bracket for mounting

Ref. No.	Art. No.	EAN 4003318	Version	Weight g	Carrier	Box Qty
Bracket GH 50	10000904-01	00904 4		196	for 64, 51, 47, 46, 470, 460, 32	66

## BRACKET UGH 02



### TECHNICAL DATA

- Transport of Steel-0-Flex and other locks
- Mounting on the rack stays with a diameter of 5 - 16.5 mm
- Universal solution for all common racks
- Simple and time saving mounting

Ref. No.	Art. No.	EAN 4003318	Version	Weight g	Carrier	Box Qty
Bracket UGH 02	10026624-01	26624 9		80	for 32, 410, 440, 460, 420, 470, 640, 540, 59	66

## SHACKLE CLAMP



### TECHNICAL DATA

- Accessory for the transport in a TUBUS LOCC U-shackle lock carrier, TexKF Twin, RBKF Twin or USKF

Ref. No.	Art. No.	EAN 4003318	Version	Weight g	Carrier	Box Qty
Shackle Clamp 12mm	10025604-01	25604 2	Ø 12 mm	21	for 46, 47, 460, 470, 640	1
Shackle Clamp 13mm	10027348-01	27348 3	Ø 13 mm	30	for 540, 770A	1

## BRACKET SH SF SADDLEFIX



### TECHNICAL DATA

- Universal adapter for space-saving attachment of various BORDO™ locks to saddle stays
- Your desired BORDO™ lock can be fixed to the adapter together with the corresponding bracket
- A rain cap is included in the scope of delivery: as splash and weather protection for your BORDO™ lock
- The holes on the adapter are analogous to those on a water bottle holder, so that this or the SportFlex lock could also be fixed to the adapter
- Screws are included in the scope of delivery
- Adapter for attachment to the saddle
- Suitable for brackets SH 5700, 6000 and 6500
- Practical rain cover and protection against dirt and moisture

Ref. No.	Art. No.	EAN 4003318	Version	Weight g	Carrier	Box Qty
Bracket SH SF	10067866-01	67866 0	mit Rain Cap	121	for SH 5700/80, SH 6000/90, SH 6000/120, SH 6500/85	3

## BRACKET SH 6500A ONE



### TECHNICAL DATA

- For easy transportation of the BORDO 6500A One
- Simple mounting with fixing strap or Velcro strap
- Does not require much space, as the lock can be removed from the front
- Ideal for small frame geometries

Ref. No.	Art. No.	EAN 4003318	Version	Weight g	Carrier	Box Qty
Bracket SH 6500A One	10063488-01	63488 8		148	for 6500A/110	1

## BRACKET SH 6500K BORDO™



### TECHNICAL DATA

- For easy transportation of the BORDO™ 6500K and 6500KA
- Easy mounting thanks to practical fixing strap holder
- Fits in compact spaces thanks to front loading of the lock
- Ideal for smaller frame sizes
- Holder for safe transport of the lock on the bike

Ref. No.	Art. No.	EAN 4003318	Version	Weight g	Carrier	Box Qty
Bracket SH 6500K/90	10069051-01	69051 8		195	for 6500KA/90, 6500K/90	3
Bracket SH 6500K/120	10096279-01	96279 0		230	for 6500K/120	1

## BRACKET SH 6500 BORDO XPLUS™



### TECHNICAL DATA

- Easy transport for BORDO™ 6500
- Easy mounting thanks to practical fixing strap holder
- The lock can be easily removed forwards
- Perfect for small framed bikes

Ref. No.	Art. No.	EAN 4003318	Version	Weight g	Carrier	Box Qty
Bracket SH 6500/110	10061556-01	61556 6		172	for 6500/110	3

## BRACKET SH 6200K



### TECHNICAL DATA

- For easy transport of the BORDO 6200K
- Easy mounting thanks to practical fixing strap holder
- Does not require much space, as the lock can be removed from the front
- Ideal for small bike frames
- Storage compartment for tracker: an AirTag\* or SmartTag\*\* (Generation 1) can be hidden in the holder

Ref. No.	Art. No.	EAN 4003318	Version	Weight g	Carrier	Box Qty
Bracket SH 6200K/90	10094474-01	94474 1		165	for 6200K/90	3
Bracket SH 6200K/120	10041928-01	41928 7		165	for 6200K/120	3

\*AirTag ist eine Marke der Apple Inc., eingetragen in den USA und anderen Ländern und Regionen. \*\*Samsung SmartTag ist eine eingetragene Marke der SAMSUNG ELECTRONICS CO., LTD.

## BRACKET SH 6000 BORDO™



### TECHNICAL DATA

- Easy transport for BORDO™ 6000K, 6000KA, 6000C, 6000, 6000A and 6100
- Easy mounting thanks to practical fixing strap holder
- The lock can be easily removed forwards
- Perfect for small framed bikes

Ref. No.	Art. No.	EAN 4003318	Version	Weight g	Carrier	Box Qty
Bracket SH 6000/90	10061543-01	61543 6		115	for 6000/90, 6000K/90, 6000KA/90, 6000C/90, 6000A/90, 6100/90	3

## BRACKET SH FL-BORDO MOUNT



### TECHNICAL DATA

- For easy transportation of the BORDO 6000K/90, 6000C/90 or the 6000KA/90
- Simple and super-fast magnetic attachment to the Fidlock TWIST bike base
- Does not require much space, as the lock can be removed from the front
- The BORDO 6000K/90 and 6000C/90 are also available individually without brackets

Ref. No.	Art. No.	EAN 4003318	Version	Weight g	Carrier	Box Qty
Bracket SHFL 6000/90	10088886-01	88886 1		160	for 6000/90, 6100/90, 6000A/90, 6000K/90, 6000C/90, 6000KA/90	3

## BRACKET SH 6000 BORDO™ BIG



### TECHNICAL DATA

- Easy transport for BORDO™ 6000 Big, 6000K Big, 6000KA Big, 6000C/120, 6000AF/120 and 6000A Big
- Easy mounting thanks to practical fixing strap holder
- The lock can be easily removed forwards
- Perfect for small framed bikes

Ref. No.	Art. No.	EAN 4003318	Version	Weight g	Carrier	Box Qty
Bracket SH 6000/120	10061564-01	61564 1		132	for 6000/120, 6000K/120, 6000KA/120, 6000C/120, 6000AF/120, 6000A/120	3

## BRACKET SH 5700 UGRIP BORDO



### TECHNICAL DATA

- Easy transport for BORDO 5700K uGrip
- Simple and toolless mounting due to practical mounting straps
- The lock can be easily removed forwards
- Perfect for small framed bikes

Ref. No.	Art. No.	EAN 4003318	Version	Weight g	Carrier	Box Qty
Bracket SH 5700/80	10061566-01	61566 5		122	for 5700K/80 und 5700C/80	3

## BRACKET SH 5700 UGRIP BORDO BIG



### TECHNICAL DATA

- Easy transport for BORDO 5700 uGrip BIG
- Easy mounting thanks to practical fixing strap holder
- The lock can be easily removed forwards
- Perfect for small framed bikes

Ref. No.	Art. No.	EAN 4003318	Version	Weight g	Carrier	Box Qty
Bracket SH 5700K/100	10061571-01	61571 9		122	5700K/100	3

## BRACKET SH 6055 BORDO™ LITE



### TECHNICAL DATA

- For easy transportation of the BORDO 6055 Lite and Lite Mini (both Key and Combo variants)
- The lock can be easily removed forwards
- Perfect for small framed bikes

Ref. No.	Art. No.	EAN 4003318	Version	Weight g	Carrier	Box Qty
Bracket SH 6055	10061572-01	61572 6		60	for 6055K/60, 6055K/85, 6055C/60 und 6055C/85	3

## BRACKET SR 6055 SELLE ROYAL



### TECHNICAL DATA

- For easy transportation of the BORDO 6055 Lite and Lite Mini (both Key and Combo variants)
- Easy mounting under Selle Royal saddles
- Ideal for use on road bikes

Ref. No.	Art. No.	EAN 4003318	Version	Weight g	Carrier	Box Qty
Bracket SR 6055 Selle Royal	10063151-01	63151 1		64	for 6055K/60, 6055K/85, 6055C/60 und 6055C/85	3

## BRACKET ST 6000 BORDO™



### TECHNICAL DATA

- Flexible mounting with non-slip velcro straps or bolts using the bottle cage fittings
- Easy transport thanks to practical holder
- Suitable for BORDO 6000C/90, 6000K/90, 6000/90 and 6100/90

Ref. No.	Art. No.	EAN 4003318	Version	Weight g	Carrier	Box Qty
Bracket ST 6000/90 black	10054297-01	54297 8		125	6000/90 und 6100/90	1

## BRACKET ST 6000 BORDO™ BIG



### TECHNICAL DATA

- Flexible mounting with non-slip velcro straps or bolts using the bottle cage fittings
- Easy transport thanks to practical holder
- Suitable for BORDO 6000K/120, 6000/120 and 6000A/120

Ref. No.	Art. No.	EAN 4003318	Version	Weight g	Carrier	Box Qty
Bracket ST 6000/120 black	10055327-01	55327 1		160	6000K/120, 6000/120 und 6000A/120	1

## BRACKET ST 5700 UGRIP BORDO™



### TECHNICAL DATA

- Transport bag with latching mechanism and comfortable one-hand-operation
- Flexible mounting with non-slip velcro straps or bolts using the bottle cage fittings
- Easy transport thanks to practical holder
- Suitable for BORDO 5700K/80

Ref. No.	Art. No.	EAN 4003318	Version	Weight g	Carrier	Box Qty
Bracket ST 5700/80 uGrip BORDO	10011284-01	11284 3		103	for 5700K/80	1

## BRACKET IVERA RBU



### TECHNICAL DATA

- Transport of chain, cable and Steel-o-flex locks of the Ivera series
- For mounting on round and non-round frame profiles with a diameter of 15 - 45 mm or for practical mounting on the seat clamp
- Easy mounting with a metal sleeve or LL bracket

Ref. No.	Art. No.	EAN 4003318	Version	Weight g	Carrier	Box Qty
Bracket IVERA RBU	10058497-01	58497 8		125	for 7200, 7210, 7220 IVERA	1

## BRACKET SNAP CAGE



### TECHNICAL DATA

- Transport of Steel-0-Flex, cable- and coil cable locks
- Enables transporting the lock on the seat post, on the frame and on the rack stays
- With a diameter of 15 - 55 mm
- Simple mounting without tools

Ref. No.	Art. No.	EAN 4003318	Version	Weight g	Carrier	Box Qty
Bracket Snap Cage MU 6K	10020079-01	20079 3		40	for 6412K, 6512K, 6615K	12
Bracket Snap Cage MU 4K/5K	10020080-01	20080 9		40	for 4508K, 5510K, 5412K	12
Bracket Snap Cage MU 4C/5C	10020111-01	20111 0		40	for 4508C, 5412C, 5510C	12
Bracket Snap Cage MU 6C	10020113-01	20113 4		40	for 6412C, 6512C, 6615C	12

## BRACKET SCLL



### TECHNICAL DATA

- Transport of cable, coil cable and Steel-0-Flex locks
- Mounting on all common seat post bolts (diameter 5-8 mm)
- Easy mounting

Ref. No.	Art. No.	EAN 4003318	Version	Weight g	Carrier	Box Qty
Bracket SCLL 6K	10087984-01	87984 5		47	for 6412K, 6512K, 6615K	12
Bracket SCLL 4C/5C	10087981-01	87981 4		47	for 4508C, 5412C, 5510C	12

## BRACKET FL



### TECHNICAL DATA

- Exclusively for the transport of the Phantom 8960, 8950 and 8940
- For the effortless magnetic mounting on and handy removal from the bracket
- Mounting on all common seat post bolts (diameter 5-8 mm)
- Easy mounting

Ref. No.	Art. No.	EAN 4003318	Version	Weight g	Carrier	Box Qty
Bracket FL	10039729-01	39729 5		61	for Phantom 8960, 8950, 8940	1

## BRACKET TEXKF MINI



### TECHNICAL DATA

- Transport mostly cable, coil cable and Steel-0-Flex locks
- Mounting on round and non-round frame profiles with a diameter of 21 - 80 mm
- Flexible textile sleeve for mounting
- Mounting within the frame or at the side possible
- Simple and time saving mounting

Ref. No.	Art. No.	EAN 4003318	Version	Weight g	Carrier	Box Qty
Bracket TexKF Mini	10023265-01	23265 7		70	for 640, 1460, 8950, 1450, 8940	46

## FMU 6950



### TECHNICAL DATA

- For attaching frame locks to bicycle frames

Ref. No.	Art. No.	EAN 4003318	Version	Weight g	Carrier	Box Qty
FMU 6950 2 Pieces	10096201-01	96201 1		40	for alle ABUS frame locks	1

## MOUNTING STRAP



### TECHNICAL DATA

- For attaching frame locks to bicycle frames

Ref. No.	Art. No.	EAN 4003318	Version	Weight g	Carrier	Box Qty
Mounting strap LH adaptor	10056240-01	56240 2		48	for all ABUS frame locks	80

## CHAIN BAG ST 2012



### TECHNICAL DATA

- Bag designed for the protected transport of lock-chain-combinations
- Flexible mounting with non-slip velcro straps or screws at the bottle holder device
- 2 mm strong neoprene to keep the content cool or warm
- Strengthened inner-plate for easy mounting

Ref. No.	Art. No.	EAN 4003318	Version	Weight g	Carrier	Box Qty
ST 2012 Chain Bag	10058496-01	58496 1	Transport bag 0,6 Liter	188		1

## BAG ST 5850/5650/4960



### TECHNICAL DATA

- Bag for the protected transport of frame locks and accessories
- Convenient mounting on the carrier

Ref. No.	Art. No.	EAN 4003318	Version	Weight g	Carrier	Box Qty
Bag ST 5850/5650/4960	10048647-01	48647 0	Transport bag 160 mm / 250 mm / 50 mm	100		1

## ST 5050



### TECHNICAL DATA

- Saddle bag with Velcro fastening
- Water-repellent fabric
- Saddle bag for insert chains up to 130 cm long
- Velcro strap can be attached to the front and back using tabs
- Depending on how it is attached, the bag can be opened to the left or right
- Easy access to the saddlebag, even when the rack is full

Ref. No.	Art. No.	EAN 4003318	Capacity l	Width mm	Height mm	Depth mm	Version	Box Qty
ST 5050	10040992-01	40992 9	1	95	75	150	Velcro strap	60

## ST 1010



### TECHNICAL DATA

- Robust multi use bag made of nylon with handle
- Practical for transporting chain locks, tools and small parts

Ref. No.	Art. No.	EAN 4003318	Capacity l	Width mm	Height mm	Depth mm	Version	Box Qty
ST 1010	10023207-01	23207 7	2	270	170	45		1

## ORYDE ST 2250



### TECHNICAL DATA

- 1.8 litres stowing capacity
- Water-repellent and robust materials 420D and Scotch Rip 58
- Stable shape
- Reflective applications
- Practical interior design with key hook
- Very ample main compartment
- Frame bag for every day and leisure use

Ref. No.	Art. No.	EAN 4003318	Capacity l	Width mm	Height mm	Depth mm	Version	Box Qty
ST 2250	10008469-01	08469 0	1,8	235	195	50	Velcro strap	1

## ORYDE ST 2200



### TECHNICAL DATA

- 1.2 litres stowing capacity
- Water-repellent and robust materials 420D and Scotch Rip 58
- Stable shape
- Reflective applications
- Practical interior design with key hook
- Very ample main compartment
- Frame bag for every day and leisure use

Ref. No.	Art. No.	EAN 4003318	Capacity l	Width mm	Height mm	Depth mm	Version	Box Qty
ST 2200	10008470-01	08470 6	1,2	255	100	50	Velcro strap	1

## ORYDE ST 2085



### TECHNICAL DATA

- 0.7 litre stowing capacity
- Water-repellent and robust materials 420D and Scotch Rip 58
- Stable shape
- Reflective applications
- Practical interior design with key hook
- Particularly simple to fill due to ABUS Easy Flap System
- Includes rain cover with reflective logo
- Saddle bag for every day, sport and leisure use

Ref. No.	Art. No.	EAN 4003318	Capacity l	Width mm	Height mm	Depth mm	Version	Box Qty
ST 2085 KF	10008479-01	08479 9	0,7	75	70	145	KLICKfix®	1

## ORYDE ST 2100



### TECHNICAL DATA

- 1.2 litre stowing capacity
- Water-repellent and robust materials 420D and Scotch Rip 58
- Stable shape
- Reflective applications
- Practical interior design with key hook
- Expandable pullout to increase stowing capacity
- Saddle bag for every day, sport and leisure use

Ref. No.	Art. No.	EAN 4003318	Capacity l	Width mm	Height mm	Depth mm	Version	Box Qty
ST 2100 KF	10008472-01	08472 0	1,2	80	95	150	KLICKfix®	6

## BASICO ST 5200



### TECHNICAL DATA

- 1.2 litres stowing capacity
- Water repellent and robust material
- Practical interior design
- Very ample main compartment
- Reflective applications
- Frame bag for every day and leisure use

Ref. No.	Art. No.	EAN 4003318	Capacity l	Width mm	Height mm	Depth mm	Version	Box Qty
ST 5200	10008482-01	08482 9	1,2	255	110	65	Velcro strap	1

## ST 5950 2.0



### TECHNICAL DATA

- Saddle bag for every day, sport and leisure use

Ref. No.	Art. No.	EAN 4003318	Capacity l	Width mm	Height mm	Depth mm	Version	Box Qty
ST 5950 2.0	10087510-01	87510 6	0,6	160	85	90	Velcro strap	48



540 6  
Made in Germany

ABUS

ABUS

WYD RECOMMENDED USE 170-310MMER 2018

## ABUS OEM

### **STRONG SERVICE PARTNER, RELIABLE SUPPLIER ABUS AS OEM PARTNER – YOUR FIRST CHOICE**



In the bicycle market, the factors of success are added value, differentiation, flexibility, availability, fast service and high capacity. Suppliers that work with bicycle manufacturers have to meet the corresponding requirements. ABUS meets them.

As a globally experienced specialist in bicycle security, we offer you the best possible support and a high level of reliability. For years, ABUS has been a synonym for security, and has earned a leading position in the bicycle accessory market.

Quality „Made in Germany“ and „Just in time“ deliveries: concentrating on these core competences has made us an important partner for many bicycle manufacturers worldwide. We are also a strong partner on the OEM market, offering a wide selection of frame locks, integrated security solutions, and many individualized products. Among others, we offer keyed alike locks and battery cylinders for e-bikes.

Allow us to take advantage of mutual synergy and implement it to our shared success!

Our OEM team looks forward to hearing from you at: [oem@abus.de](mailto:oem@abus.de)

We hope to continue our good cooperation with leading bicycle manufacturers!





**CUSTOM SECURITY**

Custom security solutions are not just a trend, but also a very convenient way for cyclists to secure their beloved bicycles. Take advantage of our more than 100 years of experience, and set yourself apart from the masses with a customized security solution.





THIS  
IS  
PURE



[abus.com](http://abus.com)

# PURE EDITION

## UNIQUE, COOL DESIGN

Discover some of our tried-and-tested bike helmet models in trendy pastel colours - the fashionable highlight for the summer!

The EPS is now in bright white for a fresh look. Get these hot helmets for your customers!

HUD-Y ACE



pure aqua

Page 212



pure mint

Page 212



pure lavender

Page 212



pure rose

Page 212



pure white

Page 212

HUD-Y



pure mint

Page 214



pure aqua

Page 214



pure lavender

Page 214



pure rose

Page 214



pure white

Page 214



puristic

Page 214

SMILEY 3.0 ACE



pure rose

Page 252



pure mint

Page 252



pure lavender

Page 252



pure aqua

Page 252

AIRBRAKER 2.0



pure white

Page 154

GAMECHANGER 2.0



pure white

Page 158



pure mint

Page 158



pure grey

Page 158

STORMCHASER ACE



pure mint

Page 166



pure grey

Page 166



pure white

Page 166





**ROAD**



**AIRBREAKER 2.0**



Page 154



**GAMECHANGER TT 1.1**



Page 156

**GAMECHANGER 2.0**



Page 158

**GAMECHANGER 2.0 RF**



Page 160



**TAIPAN LED**



Page 162



**TAIPAN**



Page 164



**STORMCHASER ACE**



Page 166

**POWERDOME ACE**



Page 168

**POWERDOME**



Page 170

**WINGBACK**











Page 172

**MACATOR**

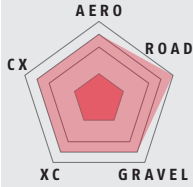
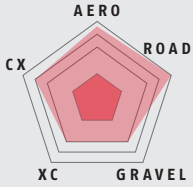
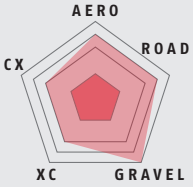
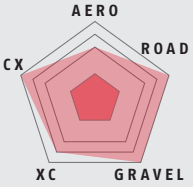

Page 174

# PRODUCT FEATURE MATRIX ROAD

	AIRBREAKER 2.0	GAMECHANGER 2.0	TAIPAN	STORMCHASER ACE
				
				
			LED   Basic	
EYEWEAR PORT	✓	✓	✓	✓
GRIDS	✓	✓	-	-
MAGNETIC REAR LIGHT	-	-	✓   Optional	-
MIPS	✓	✓	-	-
SIZES	S = 51-55 CM M=54-58 CM L=57-61CM	S = 51-55 CM M=54-58 CM L=57-61C  VERSION RF M/L= 57-61 CM	S = 51-55 CM M=54-58 CM L=57-61CM	S = 51-55 CM M=54-58 CM L=57-61CM
PRODUCTION	ITALY	ITALY	ITALY	ITALY
WEIGHT	215g	260g	275g	220g
				

POWERDOME WINGBACK MACATOR GAMECHANGER TT 1.1

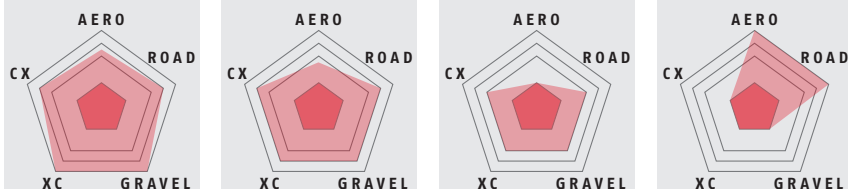

<b>EYEWEAR PORT</b>	-	-	-	-
<b>GRIDS</b>	-	-	-	-
<b>MAGNETIC REAR LIGHT</b>	-	-	-	-
<b>MIPS</b>	✓	-	✓	-
<b>SIZES</b>	S = 51-55 CM M=54-58 CM L=57-61CM	S = 51-55 CM M=54-58 CM L=57-61CM	S = 51-55 CM M=52-58 CM L=58-62CM	S = 51-55 CM M=54-58 CM L=57-61CM
<b>PRODUCTION</b>	ITALY	ITALY	CHINA	ITALY

**WEIGHT**

220g

240g

300g

360g

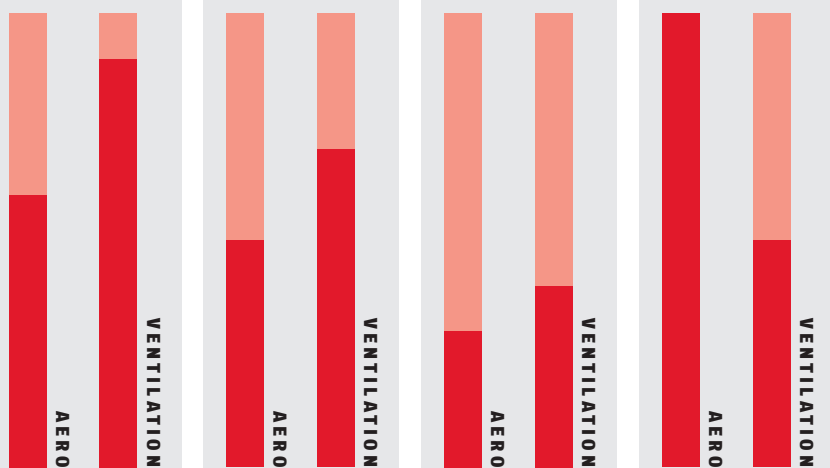

# AIRBREAKER 2.0

## VIEWS



all-in purple



all-in purple



## TECHNOLOGY



(MIPS Version)

## VERSIONS



graphite silver



velvet black



shiny white



pure white



Mips

graphite silver



Mips

velvet black



Mips

shiny white

Ref. No.	Art. No.	EAN 4003318	Colour	Finish	Weight g	Size	Head size cm
AirBreaker 2.0	10050635-01	50635 2	all-in purple	shiny	205	S	51 - 55
AirBreaker 2.0	10044541-01	44541 5	all-in purple	shiny	215	M	54 - 58
AirBreaker 2.0	10044542-01	44542 2	all-in purple	shiny	230	L	57 - 61
AirBreaker 2.0	10044525-01	44525 5	graphite silver	shiny	205	S	51 - 55
AirBreaker 2.0	10044526-01	44526 2	graphite silver	shiny	215	M	54 - 58
AirBreaker 2.0	10044527-01	44527 9	graphite silver	shiny	230	L	57 - 61
AirBreaker 2.0	10044507-01	44507 1	velvet black	matt	205	S	51 - 55
AirBreaker 2.0	10044508-01	44508 8	velvet black	matt	215	M	54 - 58
AirBreaker 2.0	10044509-01	44509 5	velvet black	matt	230	L	57 - 61
AirBreaker 2.0	10044514-01	44514 9	shiny white	shiny	205	S	51 - 55
AirBreaker 2.0	10044515-01	44515 6	shiny white	shiny	215	M	54 - 58
AirBreaker 2.0	10044516-01	44516 3	shiny white	shiny	230	L	57 - 61
AirBreaker 2.0	10044517-01	44517 0	pure white	shiny	205	S	51 - 55
AirBreaker 2.0	10044518-01	44518 7	pure white	shiny	215	M	54 - 58
AirBreaker 2.0	10044519-01	44519 4	pure white	shiny	230	L	57 - 61
AirBreaker 2.0 MIPS	10044575-01	44575 0	graphite silver	shiny	220	S	51 - 55
AirBreaker 2.0 MIPS	10044576-01	44576 7	graphite silver	shiny	230	M	54 - 58
AirBreaker 2.0 MIPS	10044587-01	44587 3	graphite silver	shiny	245	L	57 - 61
AirBreaker 2.0 MIPS	10044543-01	44543 9	velvet black	matt	220	S	51 - 55
AirBreaker 2.0 MIPS	10044544-01	44544 6	velvet black	matt	230	M	54 - 58
AirBreaker 2.0 MIPS	10044545-01	44545 3	velvet black	matt	245	L	57 - 61
AirBreaker 2.0 MIPS	10044546-01	44546 0	shiny white	shiny	220	S	51 - 55
AirBreaker 2.0 MIPS	10044568-01	44568 2	shiny white	shiny	230	M	54 - 58
AirBreaker 2.0 MIPS	10044571-01	44571 2	shiny white	shiny	245	L	57 - 61
Race Cap	10096047-01	96047 5	autumn black			M/L	56 - 61
Race Cap	10096048-01	96048 2	porto blue			M/L	56 - 61
Race Cap	10096049-01	96049 9	italian white			M/L	56 - 61
Race Cap	10096046-01	96046 8	adventure blue			M/L	56 - 61
ABUS Bag	10078592-01	78592 4	black			universal	

# GAMECHANGER TT 1.1

## VIEWS



shiny white



shiny white



## TECHNOLOGY



## VERSIONS



shiny black

Ref. No.	Art. No.	EAN 4003318	Colour	Finish	Weight g	Size	Head size cm
GameChanger TT 1.1	10094335-01	94335 5	shiny white	shiny	360	S	51 - 55
GameChanger TT 1.1	10040961-01	40961 5	shiny white	shiny	375	M	54 - 58
GameChanger TT 1.1	10040443-01	40443 6	shiny white	shiny	390	L	57 - 61
GameChanger TT 1.1	10038075-01	38075 4	shiny black	shiny	360	S	51 - 55
GameChanger TT 1.1	10094334-01	94334 8	shiny black	shiny	375	M	54 - 58
GameChanger TT 1.1	10040960-01	40960 8	shiny black	shiny	390	L	57 - 61
Visor clear S	10038199-01	38199 7	clear			S	
Visor clear M	10094470-01	94470 3	clear			M	
Visor clear L	10041082-01	41082 6	clear			L	
Visor smoke S	10038200-01	38200 0	smoke			S	
Visor smoke M	10094471-01	94471 0	smoke			M	
Visor smoke L	10041083-01	41083 3	smoke			L	
Visor chrome S	10038198-01	38198 0	chrome			S	
Visor chrome M	10094469-01	94469 7	chrome			M	
Visor chrome L	10041081-01	41081 9	chrome			L	



# GAMECHANGER 2.0

## VIEWS



pure white



pure white



## TECHNOLOGY



(MIPS Version)

## VERSIONS



pure mint



pure grey



velvet black



titan



race grey



shiny white



performance red



flip flop purple



gleam silver



moss green



polar white



black gold



MIPS

velvet black



MIPS

shiny white



MIPS

performance red



MIPS

flip flop purple

Ref. No.	Art. No.	EAN 4003318	Colour	Finish	Weight g	Size	Head size cm
GameChanger 2.0	10038066-01	38066 2	pure white	shiny	260	S	51 - 55
GameChanger 2.0	10094325-01	94325 6	pure white	shiny	265	M	54 - 58
GameChanger 2.0	10040951-01	40951 6	pure white	shiny	275	L	57 - 61
GameChanger 2.0	10094326-01	94326 3	pure mint	matt + shiny	260	S	51 - 55
GameChanger 2.0	10040952-01	40952 3	pure mint	matt + shiny	265	M	54 - 58
GameChanger 2.0	10040434-01	40434 4	pure mint	matt + shiny	275	L	57 - 61
GameChanger 2.0	10040953-01	40953 0	pure grey	shiny	260	S	51 - 55
GameChanger 2.0	10040435-01	40435 1	pure grey	shiny	265	M	54 - 58
GameChanger 2.0	10038067-01	38067 9	pure grey	shiny	275	L	57 - 61
GameChanger 2.0	10097996-01	97996 5	velvet black	matt + shiny	260	S	51 - 55
GameChanger 2.0	10097997-01	97997 2	velvet black	matt + shiny	265	M	54 - 58
GameChanger 2.0	10097998-01	97998 9	velvet black	matt + shiny	275	L	57 - 61
GameChanger 2.0	10097999-01	97999 6	titan	shiny	260	S	51 - 55
GameChanger 2.0	10098000-01	98000 8	titan	shiny	265	M	54 - 58
GameChanger 2.0	10098001-01	98001 5	titan	shiny	275	L	57 - 61
GameChanger 2.0	10098002-01	98002 2	race grey	shiny	260	S	51 - 55
GameChanger 2.0	10098003-01	98003 9	race grey	shiny	265	M	54 - 58
GameChanger 2.0	10098004-01	98004 6	race grey	shiny	275	L	57 - 61
GameChanger 2.0	10098005-01	98005 3	shiny white	shiny	260	S	51 - 55
GameChanger 2.0	10098006-01	98006 0	shiny white	shiny	265	M	54 - 58
GameChanger 2.0	10098007-01	98007 7	shiny white	shiny	275	L	57 - 61
GameChanger 2.0	10098008-01	98008 4	performance red	shiny	260	S	51 - 55
GameChanger 2.0	10098009-01	98009 1	performance red	shiny	265	M	54 - 58
GameChanger 2.0	10098010-01	98010 7	performance red	shiny	275	L	57 - 61
GameChanger 2.0	10098011-01	98011 4	flip flop purple	shiny	260	S	51 - 55
GameChanger 2.0	10098012-01	98012 1	flip flop purple	shiny	265	M	54 - 58
GameChanger 2.0	10098013-01	98013 8	flip flop purple	shiny	275	L	57 - 61
GameChanger 2.0	10098017-01	98017 6	gleam silver	matt + shiny	260	S	51 - 55
GameChanger 2.0	10098018-01	98018 3	gleam silver	matt + shiny	265	M	54 - 58
GameChanger 2.0	10098019-01	98019 0	gleam silver	matt + shiny	275	L	57 - 61
GameChanger 2.0	10098020-01	98020 6	moss green	shiny	260	S	51 - 55
GameChanger 2.0	10098021-01	98021 3	moss green	shiny	265	M	54 - 58
GameChanger 2.0	10098028-01	98028 2	moss green	shiny	275	L	57 - 61
GameChanger 2.0	10098022-01	98022 0	polar white	matt + shiny	260	S	51 - 55
GameChanger 2.0	10098023-01	98023 7	polar white	matt + shiny	265	M	54 - 58
GameChanger 2.0	10098024-01	98024 4	polar white	matt + shiny	275	L	57 - 61
GameChanger 2.0	10098025-01	98025 1	black gold	matt + shiny	260	S	51 - 55
GameChanger 2.0	10098026-01	98026 8	black gold	matt + shiny	265	M	54 - 58
GameChanger 2.0	10098027-01	98027 5	black gold	matt + shiny	275	L	57 - 61
GameChanger 2.0 MIPS	10098029-01	98029 9	velvet black	matt + shiny	275	S	51 - 55
GameChanger 2.0 MIPS	10098030-01	98030 5	velvet black	matt + shiny	290	M	54 - 58
GameChanger 2.0 MIPS	10098031-01	98031 2	velvet black	matt + shiny	300	L	57 - 61
GameChanger 2.0 MIPS	10098032-01	98032 9	shiny white	shiny	275	S	51 - 55
GameChanger 2.0 MIPS	10098033-01	98033 6	shiny white	shiny	290	M	54 - 58
GameChanger 2.0 MIPS	10098034-01	98034 3	shiny white	shiny	300	L	57 - 61
GameChanger 2.0 MIPS	10098035-01	98035 0	performance red	shiny	275	S	51 - 55
GameChanger 2.0 MIPS	10098036-01	98036 7	performance red	shiny	290	M	54 - 58
GameChanger 2.0 MIPS	10098037-01	98037 4	performance red	shiny	300	L	57 - 61
GameChanger 2.0 MIPS	10098038-01	98038 1	flip flop purple	shiny	275	S	51 - 55
GameChanger 2.0 MIPS	10098039-01	98039 8	flip flop purple	shiny	290	M	54 - 58
GameChanger 2.0 MIPS	10098040-01	98040 4	flip flop purple	shiny	300	L	57 - 61
Race Cap	10096047-01	96047 5	autumn black			M/L	56 - 61
Race Cap	10096048-01	96048 2	porto blue			M/L	56 - 61
Race Cap	10096049-01	96049 9	italian white			M/L	56 - 61
Race Cap	10096046-01	96046 8	adventure blue			M/L	56 - 61
ABUS Bag	10078592-01	78592 4	black			universal	

# GAMECHANGER 2.0 RF

VIEWS



race grey



race grey



TECHNOLOGY



(MIPS Version)

VERSIONS



velvet black



shiny white



polar white



flip flop purple



velvet black



shiny white

Ref. No.	Art. No.	EAN 4003318	Colour	Finish	Weight g	Size	Head size cm
GameChanger 2.0 RF	10044511-01	44511 8	race grey	shiny	305	M/L	57 - 61
GameChanger 2.0 RF	10044503-01	44503 3	velvet black	matt	305	M/L	57 - 61
GameChanger 2.0 RF	10044506-01	44506 4	shiny white	shiny	305	M/L	57 - 61
GameChanger 2.0 RF	10044510-01	44510 1	polar white	matt	305	M/L	57 - 61
GameChanger 2.0 RF	10044512-01	44512 5	flip flop purple	shiny	305	M/L	57 - 61
GameChanger 2.0 MIPS RF	10044523-01	44523 1	shiny white	shiny	315	M/L	57 - 61
GameChanger 2.0 MIPS RF	10044524-01	44524 8	velvet black	matt	315	M/L	57 - 61
Race Cap	10096047-01	96047 5	autumn black			M/L	56 - 61
Race Cap	10096048-01	96048 2	porto blue			M/L	56 - 61
Race Cap	10096049-01	96049 9	italian white			M/L	56 - 61
Race Cap	10096046-01	96046 8	adventure blue			M/L	56 - 61
ABUS Bag	10078592-01	78592 4	black			universal	

# TAIPAN LED

## VIEWS



shiny white



shiny white



## TECHNOLOGY



## VERSIONS



velvet black



graphite silver

Ref. No.	Art. No.	EAN 4003318	Colour	Finish	Weight g	Size	Head size cm
Taipan LED	10044651-01	44651 1	shiny white	shiny	275	S	51 - 55
Taipan LED	10044652-01	44652 8	shiny white	shiny	295	M	54 - 58
Taipan LED	10044653-01	44653 5	shiny white	shiny	315	L	57 - 61
Taipan LED	10044648-01	44648 1	velvet black	matt	275	S	51 - 55
Taipan LED	10044649-01	44649 8	velvet black	matt	295	M	54 - 58
Taipan LED	10044650-01	44650 4	velvet black	matt	315	L	57 - 61
Taipan LED	10044717-01	44717 4	graphite silver	shiny	275	S	51 - 55
Taipan LED	10044744-01	44744 0	graphite silver	shiny	295	M	54 - 58
Taipan LED	10044745-01	44745 7	graphite silver	shiny	315	L	57 - 61
Race Cap	10096047-01	96047 5	autumn black			M/L	56 - 61
Race Cap	10096048-01	96048 2	porto blue			M/L	56 - 61
Race Cap	10096049-01	96049 9	italian white			M/L	56 - 61
Race Cap	10096046-01	96046 8	adventure blue			M/L	56 - 61
ABUS Bag	10078592-01	78592 4	black			universal	

# TAIPAN

## VIEWS



sand beige



sand beige



## TECHNOLOGY



## VERSIONS



velvet black



shiny white



graphite silver



frosted green



como blue

Ref. No.	Art. No.	EAN 4003318	Colour	Finish	Weight g	Size	Head size cm
Taipan	10044645-01	44645 0	sand beige	matt	255	S	51 - 55
Taipan	10044646-01	44646 7	sand beige	matt	275	M	54 - 58
Taipan	10044647-01	44647 4	sand beige	matt	295	L	57 - 61
Taipan	10050521-01	50521 8	velvet black	matt	255	S	51 - 55
Taipan	10050583-01	50583 6	velvet black	matt	275	M	54 - 58
Taipan	10050585-01	50585 0	velvet black	matt	295	L	57 - 61
Taipan	10044631-01	44631 3	shiny white	shiny	255	S	51 - 55
Taipan	10044632-01	44632 0	shiny white	shiny	275	M	54 - 58
Taipan	10044633-01	44633 7	shiny white	shiny	295	L	57 - 61
Taipan	10044635-01	44635 1	graphite silver	shiny	255	S	51 - 55
Taipan	10044636-01	44636 8	graphite silver	shiny	275	M	54 - 58
Taipan	10044637-01	44637 5	graphite silver	shiny	295	L	57 - 61
Taipan	10044642-01	44642 9	frosted green	matt	255	S	51 - 55
Taipan	10044643-01	44643 6	frosted green	matt	275	M	54 - 58
Taipan	10044644-01	44644 3	frosted green	matt	295	L	57 - 61
Taipan	10044639-01	44639 9	como blue	shiny	255	S	51 - 55
Taipan	10044640-01	44640 5	como blue	shiny	275	M	54 - 58
Taipan	10044641-01	44641 2	como blue	shiny	295	L	57 - 61
Rear light Urban-I 4.0/Taipan	10047268-01	47268 8	black		15	universal	
Rear light ACE Urban-I 4.0/Taipan	10047269-01	47269 5	black		20	universal	
Race Cap	10096047-01	96047 5	autumn black			M/L	56 - 61
Race Cap	10096048-01	96048 2	porto blue			M/L	56 - 61
Race Cap	10096049-01	96049 9	italian white			M/L	56 - 61
Race Cap	10096046-01	96046 8	adventure blue			M/L	56 - 61
ABUS Bag	10078592-01	78592 4	black			universal	

# STORMCHASER ACE

## VIEWS



pure grey



pure grey



## TECHNOLOGY



## VERSIONS



pure mint



pure white



velvet black



race grey



performance red



flip flop purple



polar white

Ref. No.	Art. No.	EAN 4003318	Colour	Finish	Weight g	Size	Head size cm
StormChaser ACE	10038069-01	38069 3	pure mint	matt + shiny	200	S	51 - 55
StormChaser ACE	10094328-01	94328 7	pure mint	matt + shiny	220	M	54 - 58
StormChaser ACE	10040954-01	40954 7	pure mint	matt + shiny	240	L	57 - 61
StormChaser ACE	10094329-01	94329 4	pure grey	shiny	200	S	51 - 55
StormChaser ACE	10040955-01	40955 4	pure grey	shiny	220	M	54 - 58
StormChaser ACE	10040437-01	40437 5	pure grey	shiny	240	L	57 - 61
StormChaser ACE	10040436-01	40436 8	pure white	shiny	200	S	51 - 55
StormChaser ACE	10038068-01	38068 6	pure white	shiny	220	M	54 - 58
StormChaser ACE	10094327-01	94327 0	pure white	shiny	240	L	57 - 61
StormChaser ACE	10098041-01	98041 1	velvet black	matt	200	S	51 - 55
StormChaser ACE	10098042-01	98042 8	velvet black	matt	220	M	54 - 58
StormChaser ACE	10098043-01	98043 5	velvet black	matt	240	L	57 - 61
StormChaser ACE	10098044-01	98044 2	race grey	shiny	200	S	51 - 55
StormChaser ACE	10098045-01	98045 9	race grey	shiny	220	M	54 - 58
StormChaser ACE	10098046-01	98046 6	race grey	shiny	240	L	57 - 61
StormChaser ACE	10098047-01	98047 3	performance red	shiny	200	S	51 - 55
StormChaser ACE	10098048-01	98048 0	performance red	shiny	220	M	54 - 58
StormChaser ACE	10098049-01	98049 7	performance red	shiny	240	L	57 - 61
StormChaser ACE	10098050-01	98050 3	flip flop purple	shiny	200	S	51 - 55
StormChaser ACE	10098051-01	98051 0	flip flop purple	shiny	220	M	54 - 58
StormChaser ACE	10098052-01	98052 7	flip flop purple	shiny	240	L	57 - 61
StormChaser ACE	10098053-01	98053 4	polar white	matt	200	S	51 - 55
StormChaser ACE	10098054-01	98054 1	polar white	matt	220	M	54 - 58
StormChaser ACE	10098055-01	98055 8	polar white	matt	240	L	57 - 61
Race Cap	10096047-01	96047 5	autumn black			M/L	56 - 61
Race Cap	10096048-01	96048 2	porto blue			M/L	56 - 61
Race Cap	10096049-01	96049 9	italian white			M/L	56 - 61
Race Cap	10096046-01	96046 8	adventure blue			M/L	56 - 61
ABUS Bag	10078592-01	78592 4	black			universal	

# POWERDOME ACE

## VIEWS

---



race grey



race grey



## TECHNOLOGY

---



## VERSIONS

---



metallic copper

Ref. No.	Art. No.	EAN 4003318	Colour	Finish	Weight g	Size	Head size cm
PowerDome ACE	10091970-01	91970 1	race grey	shiny	210	S	51 - 55
PowerDome ACE	10091971-01	91971 8	race grey	shiny	230	M	54 - 58
PowerDome ACE	10091972-01	91972 5	race grey	shiny	250	L	57 - 61
PowerDome ACE	10091976-01	91976 3	metallic copper	matt	210	S	51 - 55
PowerDome ACE	10091977-01	91977 0	metallic copper	matt	230	M	54 - 58
PowerDome ACE	10091978-01	91978 7	metallic copper	matt	250	L	57 - 61
Race Cap	10096047-01	96047 5	autumn black			M/L	56 - 61
Race Cap	10096048-01	96048 2	porto blue			M/L	56 - 61
Race Cap	10096049-01	96049 9	italian white			M/L	56 - 61
Race Cap	10096046-01	96046 8	adventure blue			M/L	56 - 61
ABUS Bag	10078592-01	78592 4	black			universal	

# POWERDOME

## VIEWS



gleam silver



gleam silver



## TECHNOLOGY



## VERSIONS



polar white



velvet black



shiny black



shiny white



goldfish orange



blaze red



flip flop purple



gleam silver



polar white



velvet black



shiny white



blaze red



flip flop purple

Ref. No.	Art. No.	EAN 4003318	Colour	Finish	Weight g	Size	Head size cm
PowerDome	10097989-01	97989 7	gleam silver	matt + shiny	210	S	51 - 55
PowerDome	10097990-01	97990 3	gleam silver	matt + shiny	230	M	54 - 58
PowerDome	10097991-01	97991 0	gleam silver	matt + shiny	250	L	57 - 61
PowerDome	10098243-01	98243 9	polar white	matt + shiny	210	S	51 - 55
PowerDome	10098244-01	98244 6	polar white	matt + shiny	230	M	54 - 58
PowerDome	10098246-01	98246 0	polar white	matt + shiny	250	L	57 - 61
PowerDome	10091920-01	91920 6	velvet black	matt + shiny	210	S	51 - 55
PowerDome	10091921-01	91921 3	velvet black	matt + shiny	230	M	54 - 58
PowerDome	10091922-01	91922 0	velvet black	matt + shiny	250	L	57 - 61
PowerDome	10091923-01	91923 7	shiny black	shiny	210	S	51 - 55
PowerDome	10091924-01	91924 4	shiny black	shiny	230	M	54 - 58
PowerDome	10091925-01	91925 1	shiny black	shiny	250	L	57 - 61
PowerDome	10091929-01	91929 9	shiny white	shiny	210	S	51 - 55
PowerDome	10091930-01	91930 5	shiny white	shiny	230	M	54 - 58
PowerDome	10091934-01	91934 3	shiny white	shiny	250	L	57 - 61
PowerDome	10091940-01	91940 4	goldfish orange	shiny	210	S	51 - 55
PowerDome	10091941-01	91941 1	goldfish orange	shiny	230	M	54 - 58
PowerDome	10091942-01	91942 8	goldfish orange	shiny	250	L	57 - 61
PowerDome	10091943-01	91943 5	blaze red	shiny	210	S	51 - 55
PowerDome	10091944-01	91944 2	blaze red	shiny	230	M	54 - 58
PowerDome	10091945-01	91945 9	blaze red	shiny	250	L	57 - 61
PowerDome	10091946-01	91946 6	flip flop purple	shiny	210	S	51 - 55
PowerDome	10091947-01	91947 3	flip flop purple	shiny	230	M	54 - 58
PowerDome	10091948-01	91948 0	flip flop purple	shiny	250	L	57 - 61
PowerDome MIPS	10097992-01	97992 7	gleam silver	matt + shiny	240	S	51 - 55
PowerDome MIPS	10097993-01	97993 4	gleam silver	matt + shiny	260	M	54 - 58
PowerDome MIPS	10097994-01	97994 1	gleam silver	matt + shiny	280	L	57 - 61
PowerDome MIPS	10098248-01	98248 4	polar white	matt + shiny	240	S	51 - 55
PowerDome MIPS	10098249-01	98249 1	polar white	matt + shiny	260	M	54 - 58
PowerDome MIPS	10098250-01	98250 7	polar white	matt + shiny	280	L	57 - 61
PowerDome MIPS	10091949-01	91949 7	velvet black	matt + shiny	240	S	51 - 55
PowerDome MIPS	10091950-01	91950 3	velvet black	matt + shiny	260	M	54 - 58
PowerDome MIPS	10091951-01	91951 0	velvet black	matt + shiny	280	L	57 - 61
PowerDome MIPS	10091958-01	91958 9	shiny white	shiny	240	S	51 - 55
PowerDome MIPS	10091959-01	91959 6	shiny white	shiny	260	M	54 - 58
PowerDome MIPS	10091960-01	91960 2	shiny white	shiny	280	L	57 - 61
PowerDome MIPS	10091964-01	91964 0	blaze red	shiny	240	S	51 - 55
PowerDome MIPS	10091965-01	91965 7	blaze red	shiny	260	M	54 - 58
PowerDome MIPS	10091966-01	91966 4	blaze red	shiny	280	L	57 - 61
PowerDome MIPS	10091967-01	91967 1	flip flop purple	shiny	240	S	51 - 55
PowerDome MIPS	10091968-01	91968 8	flip flop purple	shiny	260	M	54 - 58
PowerDome MIPS	10091969-01	91969 5	flip flop purple	shiny	280	L	57 - 61
Race Cap	10096047-01	96047 5	autumn black			M/L	56 - 61
Race Cap	10096048-01	96048 2	porto blue			M/L	56 - 61
Race Cap	10096049-01	96049 9	italian white			M/L	56 - 61
Race Cap	10096046-01	96046 8	adventure blue			M/L	56 - 61
ABUS Bag	10078592-01	78592 4	black			universal	



# WINGBACK

## VIEWS



flip flop purple



flip flop purple



## TECHNOLOGY



## VERSIONS



velvet black



titan



race grey



shiny white



performance red



goldfish orange



gleam silver



moss green



polar white

Ref. No.	Art. No.	EAN 4003318	Colour	Finish	Weight g	Size	Head size cm
WingBack	10098071-01	98071 8	flip flop purple	shiny	230	S	51 - 55
WingBack	10098072-01	98072 5	flip flop purple	shiny	240	M	54 - 58
WingBack	10098073-01	98073 2	flip flop purple	shiny	270	L	57 - 61
WingBack	10098056-01	98056 5	velvet black	matt	230	S	51 - 55
WingBack	10098057-01	98057 2	velvet black	matt	240	M	54 - 58
WingBack	10098058-01	98058 9	velvet black	matt	270	L	57 - 61
WingBack	10098059-01	98059 6	titan	shiny	230	S	51 - 55
WingBack	10098060-01	98060 2	titan	shiny	240	M	54 - 58
WingBack	10098061-01	98061 9	titan	shiny	270	L	57 - 61
WingBack	10098062-01	98062 6	race grey	shiny	230	S	51 - 55
WingBack	10098063-01	98063 3	race grey	shiny	240	M	54 - 58
WingBack	10098064-01	98064 0	race grey	shiny	270	L	57 - 61
WingBack	10098065-01	98065 7	shiny white	shiny	230	S	51 - 55
WingBack	10098066-01	98066 4	shiny white	shiny	240	M	54 - 58
WingBack	10098067-01	98067 1	shiny white	shiny	270	L	57 - 61
WingBack	10098068-01	98068 8	performance red	shiny	230	S	51 - 55
WingBack	10098069-01	98069 5	performance red	shiny	240	M	54 - 58
WingBack	10098070-01	98070 1	performance red	shiny	270	L	57 - 61
WingBack	10098074-01	98074 9	goldfish orange	shiny	230	S	51 - 55
WingBack	10098075-01	98075 6	goldfish orange	shiny	240	M	54 - 58
WingBack	10098076-01	98076 3	goldfish orange	shiny	270	L	57 - 61
WingBack	10098077-01	98077 0	gleam silver	shiny	230	S	51 - 55
WingBack	10098078-01	98078 7	gleam silver	shiny	240	M	54 - 58
WingBack	10098079-01	98079 4	gleam silver	shiny	270	L	57 - 61
WingBack	10098080-01	98080 0	moss green	shiny	230	S	51 - 55
WingBack	10098081-01	98081 7	moss green	shiny	240	M	54 - 58
WingBack	10098082-01	98082 4	moss green	shiny	270	L	57 - 61
WingBack	10098083-01	98083 1	polar white	matt	230	S	51 - 55
WingBack	10098084-01	98084 8	polar white	matt	240	M	54 - 58
WingBack	10098085-01	98085 5	polar white	matt	270	L	57 - 61
ABUS Bag	10078592-01	78592 4	black			universal	

Road



# MACATOR

## VIEWS



velvet black



velvet black



## TECHNOLOGY



## VERSIONS



titan



steel blue



signal yellow



shiny rose



pearl white



midnight blue



gleam silver



blaze red



pearl white



shiny black



signal yellow

Ref. No.	Art. No.	EAN 4003318	Colour	Finish	Weight g	Size	Head size cm
Macator	10087214-01	87214 3	velvet black	shiny	280	S	51 - 55
Macator	10087212-01	87212 9	velvet black	shiny	300	M	52 - 58
Macator	10087213-01	87213 6	velvet black	shiny	360	L	58 - 62
Macator	10087215-01	87215 0	titan	shiny	280	S	51 - 55
Macator	10087216-01	87216 7	titan	shiny	300	M	52 - 58
Macator	10087217-01	87217 4	titan	shiny	360	L	58 - 62
Macator	10087242-01	87242 6	steel blue	shiny	280	S	51 - 55
Macator	10087243-01	87243 3	steel blue	shiny	300	M	52 - 58
Macator	10087244-01	87244 0	steel blue	shiny	360	L	58 - 62
Macator	10087229-01	87229 7	signal yellow	shiny	280	S	51 - 55
Macator	10087230-01	87230 3	signal yellow	shiny	300	M	52 - 58
Macator	10087231-01	87231 0	signal yellow	shiny	360	L	58 - 62
Macator	10067334-01	67334 4	shiny rose	shiny	280	S	51 - 55
Macator	10067335-01	67335 1	shiny rose	shiny	300	M	52 - 58
Macator	10067336-01	67336 8	shiny rose	shiny	360	L	58 - 62
Macator	10067331-01	67331 3	pearl white	shiny	280	S	51 - 55
Macator	10067332-01	67332 0	pearl white	shiny	300	M	52 - 58
Macator	10067333-01	67333 7	pearl white	shiny	360	L	58 - 62
Macator	10067325-01	67325 2	midnight blue	shiny	280	S	51 - 55
Macator	10067326-01	67326 9	midnight blue	shiny	300	M	52 - 58
Macator	10067327-01	67327 6	midnight blue	shiny	360	L	58 - 62
Macator	10087218-01	87218 1	gleam silver	shiny	280	S	51 - 55
Macator	10087219-01	87219 8	gleam silver	shiny	300	M	52 - 58
Macator	10087220-01	87220 4	gleam silver	shiny	360	L	58 - 62
Macator	10087221-01	87221 1	blaze red	shiny	280	S	51 - 55
Macator	10087222-01	87222 8	blaze red	shiny	300	M	52 - 58
Macator	10087223-01	87223 5	blaze red	shiny	360	L	58 - 62
Macator MIPS	10089222-01	89222 6	signal yellow	shiny	290	S	51 - 55
Macator MIPS	10089221-01	89221 9	signal yellow	shiny	320	M	52 - 58
Macator MIPS	10089220-01	89220 2	signal yellow	shiny	370	L	58 - 62
Macator MIPS	10096147-01	96147 2	pearl white	shiny	290	M	52 - 58
Macator MIPS	10096148-01	96148 9	pearl white	shiny	310	L	58 - 62
Macator MIPS	10096150-01	96150 2	shiny black	shiny	290	M	52 - 58
Macator MIPS	10096151-01	96151 9	shiny black	shiny	310	L	58 - 62
Race Cap	10096047-01	96047 5	autumn black			M/L	56 - 61
Race Cap	10096048-01	96048 2	porto blue			M/L	56 - 61
Race Cap	10096049-01	96049 9	italian white			M/L	56 - 61
Race Cap	10096046-01	96046 8	adventure blue			M/L	56 - 61
ABUS Bag	10078592-01	78592 4	black			universal	



**MTB**



**AIRDROP**



Page 180

**HIDROP**



Page 182

**CLIFFHANGER**



Page 184

**MOVENTOR 2.0**



Page 186

**MODROP**



Page 188

**MOTRIP**



Page 190

**INDY**



Page 192

**BUTEQ**



Page 194

MTB

# PRODUCT FEATURE MATRIX MTB

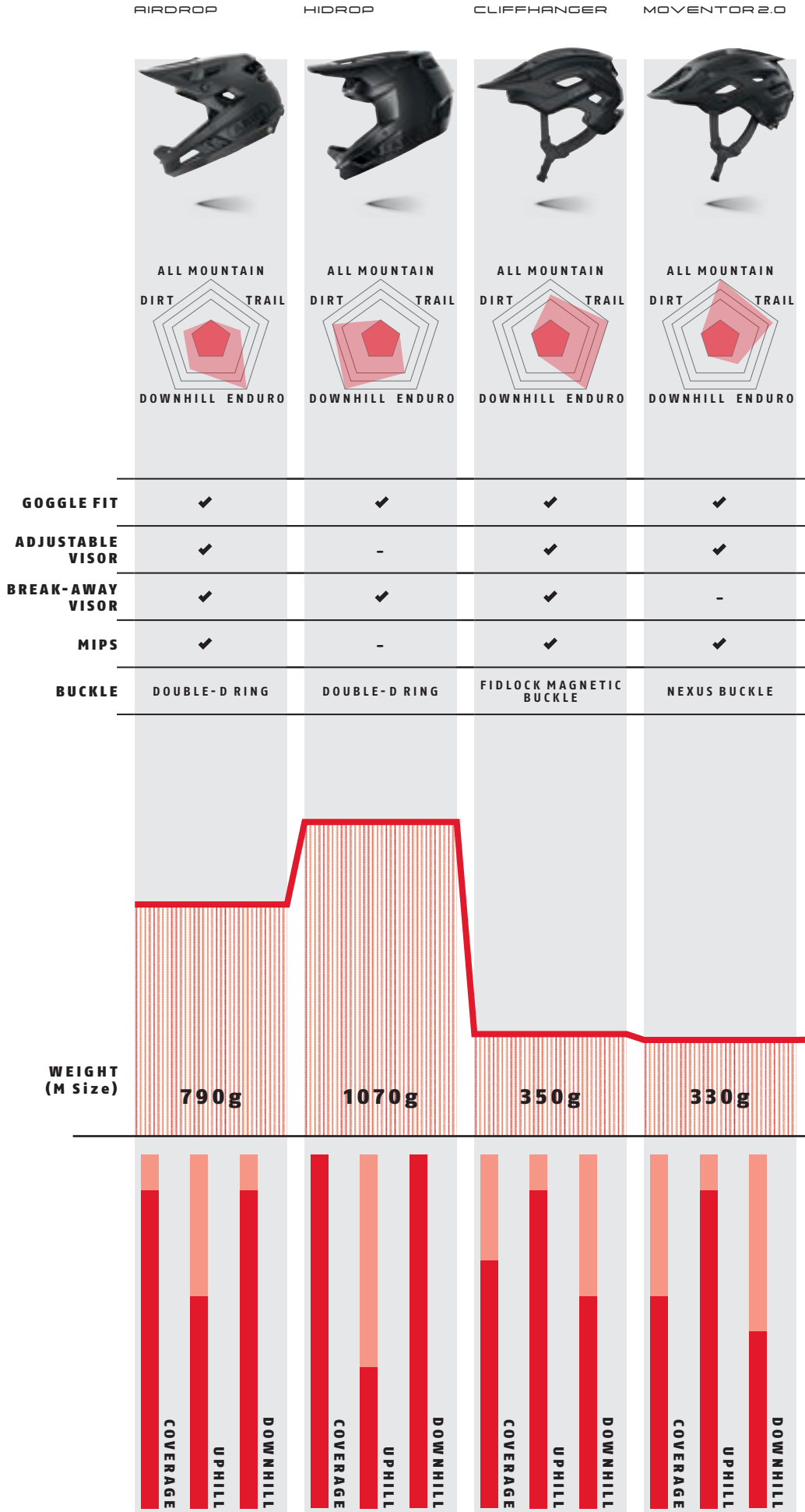

MODROP

INDY

MOTRIP



<b>GOGGLE FIT</b>	✓	-	✓
<b>ADJUSTABLE VISOR</b>	✓	NO VISOR	✓
<b>BREAK-AWAY VISOR</b>	-	NO VISOR	-
<b>MIPS</b>	✓	-	✓
<b>BUCKLE</b>	NEXUS BUCKLE	NEXUS BUCKLE	NEXUS BUCKLE

**WEIGHT (M Size)**

**370g**

**310g**

**370g**

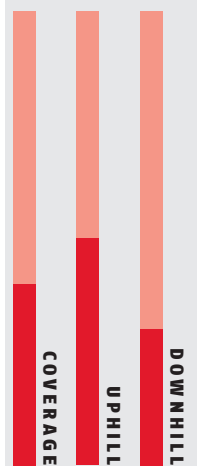
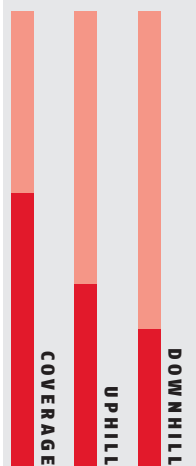
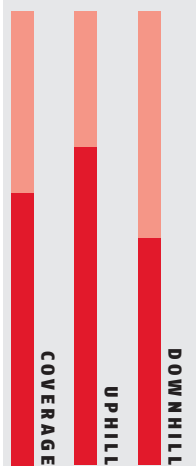

# AIRDROP

## VIEWS



concrete grey



concrete grey



## TECHNOLOGY



## VERSIONS



Mips

black gold



Mips

polar white



Mips

velvet black

Ref. No.	Art. No.	EAN 4003318	Colour	Finish	Weight g	Size	Head size cm
AirDrop MIPS	10066024-01	66024 5	concrete grey	matt	790	S/M	52 - 58
AirDrop MIPS	10066026-01	66026 9	concrete grey	matt	890	L/XL	58 - 62
AirDrop MIPS	10066254-01	66254 6	black gold	matt	790	S/M	52 - 58
AirDrop MIPS	10066255-01	66255 3	black gold	matt	890	L/XL	58 - 62
AirDrop MIPS	10066022-01	66022 1	polar white	matt	790	S/M	52 - 58
AirDrop MIPS	10066023-01	66023 8	polar white	matt	890	L/XL	58 - 62
AirDrop MIPS	10065800-01	65800 6	velvet black	matt	790	S/M	52 - 58
AirDrop MIPS	10066021-01	66021 4	velvet black	matt	890	L/XL	58 - 62
Buteo	10068933-01	68933 8	infra red		140	universal	
Buteo	10068932-01	68932 1	neon yellow		140	universal	
Buteo	10068931-01	68931 4	polar white		140	universal	
Buteo	10068930-01	68930 7	velvet black		140	universal	



# HIDROP

## VIEWS



midnight blue



midnight blue



## TECHNOLOGY



## VERSIONS



shiny black



shiny white



moss green

Ref. No.	Art. No.	EAN 4003318	Colour	Finish	Weight g	Size	Head size cm
HiDrop	10098103-01	98103 6	midnight blue	shiny	1090	S	55 - 56
HiDrop	10098104-01	98104 3	midnight blue	shiny	1070	M	57 - 58
HiDrop	10098105-01	98105 0	midnight blue	shiny	1050	L	59 - 60
HiDrop	10098106-01	98106 7	midnight blue	shiny	1040	XL	61 - 62
HiDrop	10098091-01	98091 6	shiny black	shiny	1090	S	55 - 56
HiDrop	10098092-01	98092 3	shiny black	shiny	1070	M	57 - 58
HiDrop	10098093-01	98093 0	shiny black	shiny	1050	L	59 - 60
HiDrop	10098094-01	98094 7	shiny black	shiny	1040	XL	61 - 62
HiDrop	10098095-01	98095 4	shiny white	shiny	1090	S	55 - 56
HiDrop	10098096-01	98096 1	shiny white	shiny	1070	M	57 - 58
HiDrop	10098097-01	98097 8	shiny white	shiny	1050	L	59 - 60
HiDrop	10098098-01	98098 5	shiny white	shiny	1040	XL	61 - 62
HiDrop	10098099-01	98099 2	moss green	shiny	1090	S	55 - 56
HiDrop	10098100-01	98100 5	moss green	shiny	1070	M	57 - 58
HiDrop	10098101-01	98101 2	moss green	shiny	1050	L	59 - 60
HiDrop	10098102-01	98102 9	moss green	shiny	1040	XL	61 - 62
Buteo	10068933-01	68933 8	infra red		140	universal	
Buteo	10068932-01	68932 1	neon yellow		140	universal	
Buteo	10068931-01	68931 4	polar white		140	universal	
Buteo	10068930-01	68930 7	velvet black		140	universal	

MTB



# CLIFFHANGER

## VIEWS



Ti silver



Ti silver



## TECHNOLOGY



## VERSIONS



concrete grey



midnight blue



pine green



shiny white



velvet black



wildberry red



metallic copper



pine green



shiny white



concrete grey



velvet black

Ref. No.	Art. No.	EAN 4003318	Colour	Finish	Weight g	Size	Head size cm
CliffHanger	10067242-01	67242 2	Ti silver	matt	300	S	51 - 55
CliffHanger	10067243-01	67243 9	Ti silver	matt	325	M	54 - 58
CliffHanger	10067244-01	67244 6	Ti silver	matt	365	L	57 - 61
CliffHanger	10065539-01	65539 5	concrete grey	matt	300	S	51 - 55
CliffHanger	10065540-01	65540 1	concrete grey	matt	325	M	54 - 58
CliffHanger	10065541-01	65541 8	concrete grey	matt	365	L	57 - 61
CliffHanger	10065531-01	65531 9	midnight blue	matt	300	S	51 - 55
CliffHanger	10065532-01	65532 6	midnight blue	matt	325	M	54 - 58
CliffHanger	10065533-01	65533 3	midnight blue	matt	365	L	57 - 61
CliffHanger	10065534-01	65534 0	pine green	matt	300	S	51 - 55
CliffHanger	10065535-01	65535 7	pine green	matt	325	M	54 - 58
CliffHanger	10065536-01	65536 4	pine green	matt	365	L	57 - 61
CliffHanger	10065528-01	65528 9	shiny white	shiny	300	S	51 - 55
CliffHanger	10065529-01	65529 6	shiny white	shiny	325	M	54 - 58
CliffHanger	10065530-01	65530 2	shiny white	shiny	365	L	57 - 61
CliffHanger	10065525-01	65525 8	velvet black	matt	300	S	51 - 55
CliffHanger	10065526-01	65526 5	velvet black	matt	325	M	54 - 58
CliffHanger	10065527-01	65527 2	velvet black	matt	365	L	57 - 61
CliffHanger	10067239-01	67239 2	wildberry red	matt	300	S	51 - 55
CliffHanger	10067240-01	67240 8	wildberry red	matt	325	M	54 - 58
CliffHanger	10067241-01	67241 5	wildberry red	matt	365	L	57 - 61
CliffHanger MIPS	10065551-01	65551 7	metallic copper	matt	330	S	51 - 55
CliffHanger MIPS	10065552-01	65552 4	metallic copper	matt	350	M	54 - 58
CliffHanger MIPS	10065553-01	65553 1	metallic copper	matt	390	L	57 - 61
CliffHanger MIPS	10067248-01	67248 4	pine green	matt	330	S	51 - 55
CliffHanger MIPS	10067249-01	67249 1	pine green	matt	350	M	54 - 58
CliffHanger MIPS	10067306-01	67306 1	pine green	matt	390	L	57 - 61
CliffHanger MIPS	10067245-01	67245 3	shiny white	shiny	330	S	51 - 55
CliffHanger MIPS	10067246-01	67246 0	shiny white	shiny	350	M	54 - 58
CliffHanger MIPS	10067247-01	67247 7	shiny white	shiny	390	L	57 - 61
CliffHanger MIPS	10065554-01	65554 8	concrete grey	matt	330	S	51 - 55
CliffHanger MIPS	10066485-01	66485 4	concrete grey	matt	350	M	54 - 58
CliffHanger MIPS	10065555-01	65555 5	concrete grey	matt	390	L	57 - 61
CliffHanger MIPS	10065542-01	65542 5	velvet black	matt	330	S	51 - 55
CliffHanger MIPS	10065543-01	65543 2	velvet black	matt	350	M	54 - 58
CliffHanger MIPS	10065544-01	65544 9	velvet black	matt	390	L	57 - 61

MTB



# MOVENTOR 2.0

## VIEWS



wildberry red



wildberry red



## TECHNOLOGY



## VERSIONS



concrete grey



midnight blue



pine green



shiny white



velvet black



Ti silver



metallic copper



velvet black



concrete grey



pine green



shiny white

Ref. No.	Art. No.	EAN 4003318	Colour	Finish	Weight g	Size	Head size cm
Moventor 2.0	10083318-01	83318 2	wildberry red	matt	290	S	51 - 55
Moventor 2.0	10083319-01	83319 9	wildberry red	matt	300	M	54 - 58
Moventor 2.0	10083320-01	83320 5	wildberry red	matt	320	L	57 - 61
Moventor 2.0	10065502-01	65502 9	concrete grey	matt	290	S	51 - 55
Moventor 2.0	10065503-01	65503 6	concrete grey	matt	300	M	54 - 58
Moventor 2.0	10065504-01	65504 3	concrete grey	matt	320	L	57 - 61
Moventor 2.0	10065496-01	65496 1	midnight blue	matt	290	S	51 - 55
Moventor 2.0	10065497-01	65497 8	midnight blue	matt	300	M	54 - 58
Moventor 2.0	10065498-01	65498 5	midnight blue	matt	320	L	57 - 61
Moventor 2.0	10065499-01	65499 2	pine green	matt	290	S	51 - 55
Moventor 2.0	10065500-01	65500 5	pine green	matt	300	M	54 - 58
Moventor 2.0	10065501-01	65501 2	pine green	matt	320	L	57 - 61
Moventor 2.0	10065493-01	65493 0	shiny white	shiny	290	S	51 - 55
Moventor 2.0	10065494-01	65494 7	shiny white	shiny	300	M	54 - 58
Moventor 2.0	10065495-01	65495 4	shiny white	shiny	320	L	57 - 61
Moventor 2.0	10065490-01	65490 9	velvet black	matt	290	S	51 - 55
Moventor 2.0	10065491-01	65491 6	velvet black	matt	300	M	54 - 58
Moventor 2.0	10065492-01	65492 3	velvet black	matt	320	L	57 - 61
Moventor 2.0	10083321-01	83321 2	Ti silver	matt	290	S	51 - 55
Moventor 2.0	10084127-01	84127 9	Ti silver	matt	300	M	54 - 58
Moventor 2.0	10084250-01	84250 4	Ti silver	matt	320	L	57 - 61
Moventor 2.0 MIPS	10065511-01	65511 1	metallic copper	shiny	320	S	51 - 55
Moventor 2.0 MIPS	10065512-01	65512 8	metallic copper	shiny	330	M	54 - 58
Moventor 2.0 MIPS	10065513-01	65513 5	metallic copper	shiny	350	L	51 - 61
Moventor 2.0 MIPS	10065508-01	65508 1	velvet black	matt	320	S	51 - 55
Moventor 2.0 MIPS	10065509-01	65509 8	velvet black	matt	330	M	54 - 58
Moventor 2.0 MIPS	10065510-01	65510 4	velvet black	matt	350	L	57 - 61
Moventor 2.0 MIPS	10065514-01	65514 2	concrete grey	shiny	320	S	51 - 55
Moventor 2.0 MIPS	10065515-01	65515 9	concrete grey	shiny	330	M	54 - 58
Moventor 2.0 MIPS	10065516-01	65516 6	concrete grey	shiny	350	L	57 - 61
Moventor 2.0 MIPS	10087870-01	87870 1	pine green	matt	320	S	51 - 55
Moventor 2.0 MIPS	10088465-01	88465 8	pine green	matt	330	M	54 - 58
Moventor 2.0 MIPS	10088466-01	88466 5	pine green	matt	350	L	57 - 61
Moventor 2.0 MIPS	10084522-01	84522 2	shiny white	matt	320	S	51 - 55
Moventor 2.0 MIPS	10084523-01	84523 9	shiny white	matt	330	M	54 - 58
Moventor 2.0 MIPS	10085421-01	85421 7	shiny white	matt	350	L	57 - 61
Padding fly net Moventor 2.0	10091103-01	91103 3	black			universal	
ABUS Bag	10078592-01	78592 4	black			universal	

MTB



# MODROP

## VIEWS



pine green



pine green



## TECHNOLOGY



## VERSIONS



velvet black



concrete grey



midnight blue



polar white



wildberry red



Ti silver



velvet black



concrete grey



metallic copper



shiny white



pine green

Ref. No.	Art. No.	EAN 4003318	Colour	Finish	Weight g	Size	Head size cm
MoDrop	10064985-01	64985 1	pine green	matt	310	S	51 - 55
MoDrop	10064986-01	64986 8	pine green	matt	330	M	54 - 58
MoDrop	10064987-01	64987 5	pine green	matt	360	L	57 - 61
MoDrop	10064849-01	64849 6	velvet black	matt	310	S	51 - 55
MoDrop	10064851-01	64851 9	velvet black	matt	330	M	54 - 58
MoDrop	10064850-01	64850 2	velvet black	matt	360	L	57 - 61
MoDrop	10064852-01	64852 6	concrete grey	matt	310	S	51 - 55
MoDrop	10064853-01	64853 3	concrete grey	matt	330	M	54 - 58
MoDrop	10064854-01	64854 0	concrete grey	matt	360	L	57 - 61
MoDrop	10064861-01	64861 8	midnight blue	matt	310	S	51 - 55
MoDrop	10064863-01	64863 2	midnight blue	matt	330	M	54 - 58
MoDrop	10064871-01	64871 7	midnight blue	matt	360	L	57 - 61
MoDrop	10066475-01	66475 5	polar white	matt	310	S	51 - 55
MoDrop	10066476-01	66476 2	polar white	matt	330	M	54 - 58
MoDrop	10066477-01	66477 9	polar white	matt	360	L	57 - 61
MoDrop	10067601-01	67601 7	wildberry red	matt	310	S	51 - 55
MoDrop	10067612-01	67612 3	wildberry red	matt	330	M	54 - 58
MoDrop	10068077-01	68077 9	wildberry red	matt	360	L	57 - 61
MoDrop	10068981-01	68981 9	Ti silver	matt	310	S	51 - 55
MoDrop	10069056-01	69056 3	Ti silver	matt	330	M	54 - 58
MoDrop	10069079-01	69079 2	Ti silver	matt	360	L	57 - 61
MoDrop MIPS	10065739-01	65739 9	velvet black	matt	340	S	51 - 55
MoDrop MIPS	10065740-01	65740 5	velvet black	matt	370	M	54 - 58
MoDrop MIPS	10065741-01	65741 2	velvet black	matt	390	L	57 - 61
MoDrop MIPS	10065755-01	65755 9	concrete grey	matt	340	S	51 - 55
MoDrop MIPS	10065756-01	65756 6	concrete grey	matt	370	M	54 - 58
MoDrop MIPS	10065757-01	65757 3	concrete grey	matt	390	L	57 - 61
MoDrop MIPS	10065742-01	65742 9	metallic copper	matt	340	S	51 - 55
MoDrop MIPS	10065753-01	65753 5	metallic copper	matt	370	M	54 - 58
MoDrop MIPS	10065754-01	65754 2	metallic copper	matt	390	L	57 - 61
MoDrop MIPS	10069080-01	69080 8	shiny white	shiny	340	S	51 - 55
MoDrop MIPS	10069106-01	69106 5	shiny white	shiny	370	M	54 - 58
MoDrop MIPS	10069180-01	69180 5	shiny white	shiny	390	L	57 - 61
MoDrop MIPS	10069383-01	69383 0	pine green	matt	340	S	51 - 55
MoDrop MIPS	10069384-01	69384 7	pine green	matt	370	M	54 - 58
MoDrop MIPS	10072993-01	72993 5	pine green	matt	390	L	57 - 61
Padding MoTrip/MoDrop	10091096-01	91096 8	black			universal	
ABUS Bag	10078592-01	78592 4	black			universal	

MTB



# MOTRIP

## VIEWS



shiny white



shiny white



## TECHNOLOGY



## VERSIONS



shiny black



midnight blue



concrete grey



shiny white



shiny black

Ref. No.	Art. No.	EAN 4003318	Colour	Finish	Weight g	Size	Head size cm
MoTrip	10064712-01	64712 3	shiny white	shiny	340	M	54 - 58
MoTrip	10064710-01	64710 9	shiny white	shiny	350	L	57 - 61
MoTrip	10064706-01	64706 2	shiny black	shiny	320	S	51 - 55
MoTrip	10064707-01	64707 9	shiny black	shiny	340	M	54 - 58
MoTrip	10064708-01	64708 6	shiny black	shiny	350	L	57 - 61
MoTrip	10064711-01	64711 6	midnight blue	shiny	320	S	51 - 55
MoTrip	10064713-01	64713 0	midnight blue	shiny	340	M	54 - 58
MoTrip	10064714-01	64714 7	midnight blue	shiny	350	L	57 - 61
MoTrip	10064754-01	64754 3	concrete grey	shiny	340	M	54 - 58
MoTrip	10064847-01	64847 2	concrete grey	shiny	350	L	57 - 61
MoTrip MIPS	10088496-01	88496 2	shiny black	shiny	350	S	51 - 55
MoTrip MIPS	10088499-01	88499 3	shiny black	shiny	370	M	54 - 58
MoTrip MIPS	10088508-01	88508 2	shiny black	shiny	380	L	57 - 61
MoTrip MIPS	10088821-01	88821 2	shiny white	shiny	350	S	51 - 55
MoTrip MIPS	10088977-01	88977 6	shiny white	shiny	370	M	54 - 58
MoTrip MIPS	10089177-01	89177 9	shiny white	shiny	380	L	57 - 61
Padding MoTrip/MoDrop	10091096-01	91096 8	black			universal	
Padding fly net MoTrip	10091097-01	91097 5	black			universal	
ABUS Bag	10078592-01	78592 4	black			universal	

MTB



# INDY

## VIEWS



mustard yellow



mustard yellow



## TECHNOLOGY



## VERSIONS



pepper green



pure white



velvet black

Ref. No.	Art. No.	EAN 4003318	Colour	Finish	Weight g	Size	Head size cm
INDY	10038049-01	38049 5	mustard yellow	shiny	360	S	51 - 55
INDY	10040418-01	40418 4	mustard yellow	shiny	390	M	54 - 58
INDY	10040935-01	40935 6	mustard yellow	shiny	430	L	57 - 61
INDY	10094310-01	94310 2	pepper green	shiny	360	S	51 - 55
INDY	10038050-01	38050 1	pepper green	shiny	390	M	54 - 58
INDY	10040419-01	40419 1	pepper green	shiny	430	L	57 - 61
INDY	10040417-01	40417 7	pure white	matt	360	S	51 - 55
INDY	10040934-01	40934 9	pure white	matt	390	M	54 - 58
INDY	10094309-01	94309 6	pure white	matt	430	L	57 - 61
INDY	10040933-01	40933 2	velvet black	matt	360	S	51 - 55
INDY	10094308-01	94308 9	velvet black	matt	390	M	54 - 58
INDY	10038048-01	38048 8	velvet black	matt	430	L	57 - 61



# BUTEO



## TECHNICAL DATA

---

- Double layer glass to prevent fogging
- 40 mm strap for slip-free fit
- Fleece layer for maximum comfort
- Nose guard for a comfortable and secure fit
- Available with clear and mirrored tinted lenses

## VERSIONS

---



infra red

neon yellow

velvet black

Artikel- bezeichnung	Art.-Nr.	EAN 4003318	Farbe	Gewicht g	Größe
Buteo	10068933-01	68933 8	infra red	140	universal
Buteo	10068932-01	68932 1	neon yellow	140	universal
Buteo	10068931-01	68931 4	polar white	140	universal
Buteo	10068930-01	68930 7	velvet black	140	universal
Spare glass Buteos	10068934-01	68934 5	clear	15	universal
Spare glass Buteos	10068935-01	68935 2	smoke	15	universal
Spare glass Buteos	10068936-01	68936 9	red chrome	15	universal
Spare glass Buteos	10068937-01	68937 6	black chrome	15	universal



**URBAN**



**HYP-E BL-ACE**



Page 202

**HYP-E ACE**



Page 204

**HYP-E**



Page 206

**PEDELEC 2.0 ACE**



Page 208

**PEDELEC 2.0**



Page 210

**HUD-Y ACE**



Page 212

**HUD-Y**



Page 214

**URBAN-I 4.0 ACE**



Page 216

**URBAN-I 4.0**



Page 218

**URBAN-I 4.0 LR**



Page 220

**PURL-Y ACE**



Page 222

**PURL-Y**



Page 224

Urban

**HYBAN 2.0 ACE**



Page 226

**HYBAN 2.0**



Page 228

**XOXO**



Page 230

**SKURB ACE**



Page 232

**SKURB**



Page 234

**ADURO 3.0 LED**



Page 236

**ADURO 3.0**









Page 238

# PRODUCT FEATURE MATRIX URBAN

HYP-E

PEDELEC 2.0

HUD-Y

	HYP-E			PEDELEC 2.0		HUD-Y	
							
							
	BL.ACE	ACE	Basic	ACE	Basic	ACE	Basic
REAR LIGHT		✓		✓		✓	
FRONT LIGHT		✓		-		-	
INDICATOR LIGHT		✓		-		-	
BRAKE LIGHT	✓	Optional	Optional	-		-	
REFLECTOR STICKER		-		✓		✓	
NTA		✓		✓		-	
MIPS		-		-	✓	-	
PEAK / VISOR	Visor	Visor	Peak	Visor	Peak	Visor	Peak
BUG MESH		✓		✓		-	
WEATHER PROTECTION	Vent Cover Ear Pads	Vent Cover Ear Pads	Vent Cover	Rain Cap Ear Pads	Rain Cap		-
PONYTAIL FIT		✓		✓		✓	
BUCKLE	Magnetic Buckle			Magnetic Buckle		Magnetic Buckle <sup>1</sup>	
WEIGHT (Size M)	715 g	715 g	580 g	410 g	350 g	430 g	300 g
SIZE RUN	S 51 - 55 cm M 54 - 58 cm L 57 - 61 cm			S 51 - 55 cm M 52 - 57 cm L 56 - 62 cm		S 51 - 55 cm M 54 - 58 cm L 57 - 61 cm	

<sup>1</sup>PureEdition = Push-In Buckle

# PRODUCT FEATURE MATRIX URBAN

URBAN-14.0

PURL-Y

HYBAN 2.0



	URBAN-14.0			PURL-Y		HYBAN 2.0		
	ACE	Basic	LR	ACE	Basic	ACE	LED	Basic
<b>REAR LIGHT</b>	✓	✓	Optional	✓	Optional		✓	
<b>FRONT LIGHT</b>		-			-	-	✓	-
<b>INDICATOR LIGHT</b>		-			-		-	
<b>BRAKE LIGHT</b>		-			-		-	
<b>REFLECTOR STICKER</b>		✓			✓		✓	
<b>NTA</b>		-			✓		-	
<b>MIPS</b>		-			-		-	✓
<b>PEAK / VISOR</b>		Peak			Peak	Visor	Peak	Peak
<b>BUG MESH</b>		✓			✓		✓	
<b>WEATHER PROTECTION</b>		-			-	Vent Cover	-	-
<b>PONYTAIL FIT</b>		✓			✓		✓	
<b>BUCKLE</b>	Magnetic Buckle			Push-In Buckle		Magnetic Buckle	Push-In Buckle	Push-In Buckle
<b>WEIGHT (Size M)</b>	280 g	270 g	260 g	340 g	320 g	470 g	400 g	400 g
<b>SIZE RUN</b>	S 51 - 55 cm M 52 - 58 cm L 57 - 61 cm XL 60 - 64 cm			S 51 - 55 cm M 54 - 58 cm L 57 - 61 cm		S 52 - 58 cm M 56 - 61 cm XL 58 - 63 cm		

ADURO 3.0

SKURB

XOXO



LED | Basic

ACE | Basic

ECO | Basic

<b>REAR LIGHT</b>	✓   Optional	-	-
<b>FRONT LIGHT</b>	-	-	-
<b>INDICATOR LIGHT</b>	-	-	-
<b>BRAKE LIGHT</b>	-	-	-
<b>REFLECTOR STICKER</b>	✓	-	-
<b>NTA</b>	-	-	-
<b>MIPS</b>	-	-	-
<b>PEAK / VISOR</b>	Peak	-	-
<b>BUG MESH</b>	✓	-	-
<b>WEATHER PROTECTION</b>	-	-	-
<b>PONYTAIL FIT</b>	✓	✓	-
<b>BUCKLE</b>	Push-In Buckle	Push-In Buckle	Push-In Buckle
<b>WEIGHT (Size M)</b>	315 g   300 g	310 g	400 g
<b>SIZE RUN</b>	S 51 - 55 cm M 52 - 58 cm L 58 - 62 cm	S 52 - 56 cm M 55 - 59 cm L 58 - 61 cm	S 51 - 55 cm M 54 - 58 cm L 57 - 61 cm

# HYP- E BL.ACE

VIEWS



signal yellow



signal yellow



TECHNOLOGY



VERSIONS



volcano titan



gleam silver

Ref. No.	Art. No.	EAN 4003318	Colour	Finish	Weight g	Size	Head size cm
HYP-E BL.ACE	10045084-01	45084 6	signal yellow	shiny	685	S	51 - 55
HYP-E BL.ACE	10045085-01	45085 3	signal yellow	shiny	715	M	54 - 58
HYP-E BL.ACE	10045152-01	45152 2	signal yellow	shiny	745	L	57 - 61
HYP-E BL.ACE	10038060-01	38060 0	volcano titan	matt + shiny	685	S	51 - 55
HYP-E BL.ACE	10094319-01	94319 5	volcano titan	matt + shiny	715	M	54 - 58
HYP-E BL.ACE	10040945-01	40945 5	volcano titan	matt + shiny	745	L	57 - 61
HYP-E BL.ACE	10094320-01	94320 1	gleam silver	matt + shiny	685	S	51 - 55
HYP-E BL.ACE	10040946-01	40946 2	gleam silver	matt + shiny	715	M	54 - 58
HYP-E BL.ACE	10040428-01	40428 3	gleam silver	matt + shiny	745	L	57 - 61
Ear Pads	10040430-01	40430 6	black			universal	
Visor	10040947-01	40947 9	clear			S/M	
Visor	10094563-01	94563 2	clear			L	
Visor	10094321-01	94321 8	smoke			S/M	
Visor	10041168-01	41168 7	smoke			L	
Visor	10038062-01	38062 4	photochromic			S/M	
Visor	10038276-01	38276 5	photochromic			L	
Remote Control Indicator Light	10038061-01	38061 7	black			universal	
Remote Control Brake Light	10040429-01	40429 0	black			universal	



# HYP- E ACE

## VIEWS



volcano titan



volcano titan



## TECHNOLOGY



## VERSIONS



signal yellow

gleam silver

Ref. No.	Art. No.	EAN 4003318	Colour	Finish	Weight g	Size	Head size cm
HYP-E ACE	10045155-01	45155 3	signal yellow	shiny	685	S	51 - 55
HYP-E ACE	10045210-01	45210 9	signal yellow	shiny	715	M	54 - 58
HYP-E ACE	10045215-01	45215 4	signal yellow	shiny	745	L	57 - 61
HYP-E ACE	10040944-01	40944 8	volcano titan	matt + shiny	685	S	51 - 55
HYP-E ACE	10040426-01	40426 9	volcano titan	matt + shiny	715	M	54 - 58
HYP-E ACE	10038058-01	38058 7	volcano titan	matt + shiny	745	L	57 - 61
HYP-E ACE	10040427-01	40427 6	gleam silver	matt + shiny	685	S	51 - 55
HYP-E ACE	10038059-01	38059 4	gleam silver	matt + shiny	715	M	54 - 58
HYP-E ACE	10094318-01	94318 8	gleam silver	matt + shiny	745	L	57 - 61
Ear Pads	10040430-01	40430 6	black			universal	
Visor	10040947-01	40947 9	clear			S/M	
Visor	10094563-01	94563 2	clear			L	
Visor	10094321-01	94321 8	smoke			S/M	
Visor	10041168-01	41168 7	smoke			L	
Visor	10038062-01	38062 4	photochromic			S/M	
Visor	10038276-01	38276 5	photochromic			L	
Remote Control Indicator Light	10038061-01	38061 7	black			universal	
Remote Control Brake Light	10040429-01	40429 0	black			universal	



# HYP-E

VIEWS



midnight blue



midnight blue



TECHNOLOGY



VERSIONS



signal yellow    jungle green    champagne gold    volcano titan    gleam silver

Ref. No.	Art. No.	EAN 4003318	Colour	Finish	Weight g	Size	Head size cm
HYP-E	10045216-01	45216 1	signal yellow	shiny	550	S	51 - 55
HYP-E	10045217-01	45217 8	signal yellow	shiny	580	M	54 - 58
HYP-E	10045218-01	45218 5	signal yellow	shiny	610	L	57 - 61
HYP-E	10045219-01	45219 2	midnight blue	matt + shiny	550	S	51 - 55
HYP-E	10045220-01	45220 8	midnight blue	matt + shiny	580	M	54 - 58
HYP-E	10045221-01	45221 5	midnight blue	matt + shiny	610	L	57 - 61
HYP-E	10040942-01	40942 4	jungle green	matt + shiny	550	S	51 - 55
HYP-E	10040425-01	40425 2	jungle green	matt + shiny	580	M	54 - 58
HYP-E	10038056-01	38056 3	jungle green	matt + shiny	610	L	57 - 61
HYP-E	10040943-01	40943 1	champagne gold	matt + shiny	550	S	51 - 55
HYP-E	10038057-01	38057 0	champagne gold	matt + shiny	580	M	54 - 58
HYP-E	10094317-01	94317 1	champagne gold	matt + shiny	610	L	57 - 61
HYP-E	10038055-01	38055 6	volcano titan	matt + shiny	550	S	51 - 55
HYP-E	10094315-01	94315 7	volcano titan	matt + shiny	580	M	54 - 58
HYP-E	10040940-01	40940 0	volcano titan	matt + shiny	610	L	57 - 61
HYP-E	10094316-01	94316 4	gleam silver	matt + shiny	550	S	51 - 55
HYP-E	10040941-01	40941 7	gleam silver	matt + shiny	580	M	54 - 58
HYP-E	10040424-01	40424 5	gleam silver	matt + shiny	610	L	57 - 61
Ear Pads	10040430-01	40430 6	black			universal	
Visor	10040947-01	40947 9	clear			S/M	
Visor	10094563-01	94563 2	clear			L	
Visor	10094321-01	94321 8	smoke			S/M	
Visor	10041168-01	41168 7	smoke			L	
Visor	10038062-01	38062 4	photochromic			S/M	
Visor	10038276-01	38276 5	photochromic			L	
Remote Control Indicator Light	10038061-01	38061 7	black			universal	
Remote Control Brake Light	10040429-01	40429 0	black			universal	



# PEDELEC 2.0 ACE

## VIEWS



velvet black



velvet black



## TECHNOLOGY

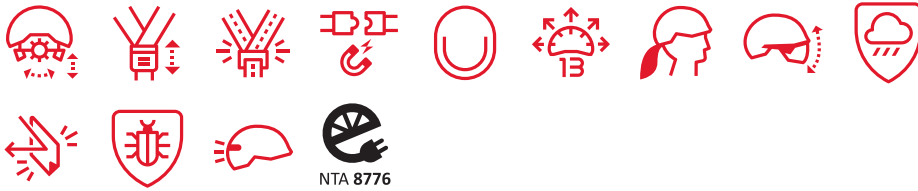

NTA 8776

## VERSIONS



signal yellow



pearl white



midnight blue



titan

Ref. No.	Art. No.	EAN 4003318	Colour	Finish	Weight g	Size	Head size cm
Pedelec 2.0 ACE	10066732-01	66732 9	velvet black	matt	390	S	51 - 55
Pedelec 2.0 ACE	10081925-01	81925 4	velvet black	matt	410	M	52 - 57
Pedelec 2.0 ACE	10081929-01	81929 2	velvet black	matt	430	L	56 - 62
Pedelec 2.0 ACE	10066735-01	66735 0	signal yellow	shiny	390	S	51 - 55
Pedelec 2.0 ACE	10081928-01	81928 5	signal yellow	shiny	410	M	52 - 57
Pedelec 2.0 ACE	10081932-01	81932 2	signal yellow	shiny	430	L	56 - 62
Pedelec 2.0 ACE	10067337-01	67337 5	pearl white	shiny	390	S	51 - 55
Pedelec 2.0 ACE	10067338-01	67338 2	pearl white	shiny	410	M	52 - 57
Pedelec 2.0 ACE	10067339-01	67339 9	pearl white	shiny	430	L	56 - 62
Pedelec 2.0 ACE	10066736-01	66736 7	midnight blue	matt	390	S	51 - 55
Pedelec 2.0 ACE	10081927-01	81927 8	midnight blue	matt	410	M	52 - 57
Pedelec 2.0 ACE	10081931-01	81931 5	midnight blue	matt	430	L	56 - 62
Pedelec 2.0 ACE	10091906-01	91906 0	titan	matt	390	S	51 - 55
Pedelec 2.0 ACE	10091907-01	91907 7	titan	matt	410	M	52 - 57
Pedelec 2.0 ACE	10091908-01	91908 4	titan	matt	430	L	56 - 62
Visor Pedelec 2.0 Hyban 2.0/HUD-Y	10082888-01	82888 1	smoke			universal	
Visor Pedelec 2.0 Hyban 2.0/HUD-Y	10082889-01	82889 8	clear			universal	



Ref. No.	Art. No.	EAN 4003318	Colour	Finish	Weight g	Size	Head size cm
Pedelec 2.0	10091897-01	91897 1	race grey	shiny	330	S	51 - 55
Pedelec 2.0	10091898-01	91898 8	race grey	shiny	350	M	52 - 57
Pedelec 2.0	10091899-01	91899 5	race grey	shiny	370	L	56 - 62
Pedelec 2.0	10040597-01	40597 6	velvet black	matt	330	S	51 - 55
Pedelec 2.0	10081919-01	81919 3	velvet black	matt	350	M	52 - 57
Pedelec 2.0	10081913-01	81913 1	velvet black	matt	370	L	56 - 62
Pedelec 2.0	10040595-01	40595 2	signal yellow	shiny	330	S	51 - 55
Pedelec 2.0	10081922-01	81922 3	signal yellow	shiny	350	M	52 - 57
Pedelec 2.0	10081916-01	81916 2	signal yellow	shiny	370	L	56 - 62
Pedelec 2.0	10040593-01	40593 8	pearl white	shiny	330	S	51 - 55
Pedelec 2.0	10040188-01	40188 6	pearl white	shiny	350	M	52 - 57
Pedelec 2.0	10040189-01	40189 3	pearl white	shiny	370	L	56 - 62
Pedelec 2.0	10040297-01	40297 5	midnight blue	matt	330	S	51 - 55
Pedelec 2.0	10081921-01	81921 6	midnight blue	matt	350	M	52 - 57
Pedelec 2.0	10081915-01	81915 5	midnight blue	matt	370	L	56 - 62
Pedelec 2.0	10091894-01	91894 0	titan	matt	330	S	51 - 55
Pedelec 2.0	10091895-01	91895 7	titan	matt	350	M	52 - 57
Pedelec 2.0	10091896-01	91896 4	titan	matt	370	L	56 - 62
Pedelec 2.0	10091903-01	91903 9	blaze red	shiny	330	S	51 - 55
Pedelec 2.0	10091904-01	91904 6	blaze red	shiny	350	M	52 - 57
Pedelec 2.0	10091905-01	91905 3	blaze red	shiny	370	L	56 - 62
Pedelec 2.0 MIPS	10089194-01	89194 6	velvet black	matt	370	M	52 - 57
Pedelec 2.0 MIPS	10089193-01	89193 9	velvet black	matt	390	L	56 - 62
Pedelec 2.0 MIPS	10089198-01	89198 4	signal yellow	shiny	370	M	52 - 57
Pedelec 2.0 MIPS	10089197-01	89197 7	signal yellow	shiny	390	L	56 - 62
Pedelec 2.0 MIPS	10089196-01	89196 0	silver edition	matt	370	M	52 - 57
Pedelec 2.0 MIPS	10089195-01	89195 3	silver edition	matt	390	L	56 - 62
Ear Pads	10083482-01	83482 0	black			universal	
Visor Pedelec 2.0 Hyban 2.0/HUD-Y	10082888-01	82888 1	smoke			universal	
Visor Pedelec 2.0 Hyban 2.0/HUD-Y	10082889-01	82889 8	clear			universal	

# HUD-Y ACE

## VIEWS



champagne gold



champagne gold



## TECHNOLOGY



Pure Edition

## VERSIONS



gleam silver



iced blue



moss green



shiny white



velvet black



pure mint



pure lavender



pure rose



pure white



pure aqua

Ref. No.	Art. No.	EAN 4003318	Colour	Finish	Weight g	Size	Head size cm
HUD-Y ACE	10099168-01	99168 4	champagne gold	matt + shiny	400	S	51 - 55
HUD-Y ACE	10099169-01	99169 1	champagne gold	matt + shiny	430	M	54 - 58
HUD-Y ACE	10099170-01	99170 7	champagne gold	matt + shiny	460	L	57 - 61
HUD-Y ACE	10099165-01	99165 3	gleam silver	shiny	400	S	51 - 55
HUD-Y ACE	10099166-01	99166 0	gleam silver	shiny	430	M	54 - 58
HUD-Y ACE	10099167-01	99167 7	gleam silver	shiny	460	L	57 - 61
HUD-Y ACE	10099162-01	99162 2	iced blue	shiny	400	S	51 - 55
HUD-Y ACE	10099163-01	99163 9	iced blue	shiny	430	M	54 - 58
HUD-Y ACE	10099164-01	99164 6	iced blue	shiny	460	L	57 - 61
HUD-Y ACE	10099159-01	99159 2	moss green	shiny	400	S	51 - 55
HUD-Y ACE	10099160-01	99160 8	moss green	shiny	430	M	54 - 58
HUD-Y ACE	10099161-01	99161 5	moss green	shiny	460	L	57 - 61
HUD-Y ACE	10091995-01	91995 4	shiny white	shiny	400	S	51 - 55
HUD-Y ACE	10091996-01	91996 1	shiny white	shiny	430	M	54 - 58
HUD-Y ACE	10091997-01	91997 8	shiny white	shiny	460	L	57 - 61
HUD-Y ACE	10091992-01	91992 3	velvet black	matt + shiny	400	S	51 - 55
HUD-Y ACE	10091993-01	91993 0	velvet black	matt + shiny	430	M	54 - 58
HUD-Y ACE	10091994-01	91994 7	velvet black	matt + shiny	460	L	57 - 61
HUD-Y ACE	10040343-01	40343 9	pure aqua	matt + shiny	400	S	51 - 55
HUD-Y ACE	10038028-01	38028 0	pure aqua	matt + shiny	430	M	54 - 58
HUD-Y ACE	10094289-01	94289 1	pure aqua	matt + shiny	460	L	57 - 61
HUD-Y ACE	10038026-01	38026 6	pure mint	matt + shiny	400	S	51 - 55
HUD-Y ACE	10094287-01	94287 7	pure mint	matt + shiny	430	M	54 - 58
HUD-Y ACE	10040911-01	40911 0	pure mint	matt + shiny	460	L	57 - 61
HUD-Y ACE	10094288-01	94288 4	pure lavender	matt + shiny	400	S	51 - 55
HUD-Y ACE	10040912-01	40912 7	pure lavender	matt + shiny	430	M	54 - 58
HUD-Y ACE	10040341-01	40341 5	pure lavender	matt + shiny	460	L	57 - 61
HUD-Y ACE	10040913-01	40913 4	pure rose	matt + shiny	400	S	51 - 55
HUD-Y ACE	10040342-01	40342 2	pure rose	matt + shiny	430	M	54 - 58
HUD-Y ACE	10038027-01	38027 3	pure rose	matt + shiny	460	L	57 - 61
HUD-Y ACE	10040340-01	40340 8	pure white	matt + shiny	400	S	51 - 55
HUD-Y ACE	10038025-01	38025 9	pure white	matt + shiny	430	M	54 - 58
HUD-Y ACE	10094286-01	94286 0	pure white	matt + shiny	460	L	57 - 61
Visor Pedelec 2.0/Hyban 2.0/HUD-Y	10082888-01	82888 1	smoke			universal	
Visor Pedelec 2.0/Hyban 2.0/HUD-Y	10082889-01	82889 8	clear			universal	
Fastening visor Pedelec 2.0/HUD-Y Hyban 2.0 ACE	10082890-01	82890 4	black			universal	
ABUS Bag	10078592-01	78592 4	black			universal	

# HUD-Y

## VIEWS



metallic copper



metallic copper



## TECHNOLOGY



Pure Edition

## VERSIONS



moss green



iced blue



gleam silver



velvet black



titan



signal yellow



race grey



champagne gold



shiny white



pure aqua



pure lavender



pure rose



pure white



puristic



pure mint

Ref. No.	Art. No.	EAN 4003318	Colour	Finish	Weight g	Size	Head size cm
HUD-Y	10097932-01	97932 3	metallic copper	matt + shiny	280	S	51 - 55
HUD-Y	10097934-01	97934 7	metallic copper	matt + shiny	300	M	54 - 58
HUD-Y	10097935-01	97935 4	metallic copper	matt + shiny	330	L	57 - 61
HUD-Y	10097936-01	97936 1	moss green	shiny	280	S	51 - 55
HUD-Y	10097937-01	97937 8	moss green	shiny	300	M	54 - 58
HUD-Y	10097938-01	97938 5	moss green	shiny	330	L	57 - 61
HUD-Y	10097939-01	97939 2	iced blue	shiny	280	S	51 - 55
HUD-Y	10097940-01	97940 8	iced blue	shiny	300	M	54 - 58
HUD-Y	10097941-01	97941 5	iced blue	shiny	330	L	57 - 61
HUD-Y	10097942-01	97942 2	gleam silver	shiny	280	S	51 - 55
HUD-Y	10097943-01	97943 9	gleam silver	shiny	300	M	54 - 58
HUD-Y	10097944-01	97944 6	gleam silver	shiny	330	L	57 - 61
HUD-Y	10091979-01	91979 4	velvet black	matt + shiny	280	S	51 - 55
HUD-Y	10066843-01	66843 2	velvet black	matt + shiny	300	M	54 - 58
HUD-Y	10066844-01	66844 9	velvet black	matt + shiny	330	L	57 - 61
HUD-Y	10091980-01	91980 0	titan	matt + shiny	280	S	51 - 55
HUD-Y	10066947-01	66947 7	titan	matt + shiny	300	M	54 - 58
HUD-Y	10067038-01	67038 1	titan	matt + shiny	330	L	57 - 61
HUD-Y	10091983-01	91983 1	signal yellow	shiny	280	S	51 - 55
HUD-Y	10067043-01	67043 5	signal yellow	shiny	300	M	54 - 58
HUD-Y	10067044-01	67044 2	signal yellow	shiny	330	L	57 - 61
HUD-Y	10091985-01	91985 5	race grey	shiny	280	S	51 - 55
HUD-Y	10067934-01	67934 6	race grey	shiny	300	M	54 - 58
HUD-Y	10067935-01	67935 3	race grey	shiny	330	L	57 - 61
HUD-Y	10091984-01	91984 8	champagne gold	matt + shiny	280	S	51 - 55
HUD-Y	10067039-01	67039 8	champagne gold	matt + shiny	300	M	54 - 58
HUD-Y	10067040-01	67040 4	champagne gold	matt + shiny	330	L	57 - 61
HUD-Y	10091986-01	91986 2	shiny white	shiny	280	S	51 - 55
HUD-Y	10091987-01	91987 9	shiny white	shiny	300	M	54 - 58
HUD-Y	10091988-01	91988 6	shiny white	shiny	330	L	57 - 61
HUD-Y	10090949-01	90949 8	pure mint	matt + shiny	280	S	51 - 55
HUD-Y	10090948-01	90948 1	pure mint	matt + shiny	300	M	54 - 58
HUD-Y	10090947-01	90947 4	pure mint	matt + shiny	330	L	57 - 61
HUD-Y	10040910-01	40910 3	pure aqua	matt + shiny	280	S	51 - 55
HUD-Y	10040339-01	40339 2	pure aqua	matt + shiny	300	M	54 - 58
HUD-Y	10038024-01	38024 2	pure aqua	matt + shiny	330	L	57 - 61
HUD-Y	10038023-01	38023 5	pure lavender	matt + shiny	280	S	51 - 55
HUD-Y	10094284-01	94284 6	pure lavender	matt + shiny	300	M	54 - 58
HUD-Y	10090952-01	90952 8	pure lavender	matt + shiny	330	L	57 - 61
HUD-Y	10094285-01	94285 3	pure rose	matt + shiny	280	S	51 - 55
HUD-Y	10040909-01	40909 7	pure rose	matt + shiny	300	M	54 - 58
HUD-Y	10040338-01	40338 5	pure rose	matt + shiny	330	L	57 - 61
HUD-Y	10090946-01	90946 7	pure white	matt + shiny	280	S	51 - 55
HUD-Y	10090944-01	90944 3	pure white	matt + shiny	300	M	54 - 58
HUD-Y	10040908-01	40908 0	pure white	matt + shiny	330	L	57 - 61
HUD-Y	10038063-01	38063 1	puristic	shiny	280	S	51 - 55
HUD-Y	10094322-01	94322 5	puristic	shiny	300	M	54 - 58
HUD-Y	10040948-01	40948 6	puristic	shiny	330	L	57 - 61
ABUS Bag	10078592-01	78592 4	black			universal	



# URBAN-I 4.0 ACE

VIEWS



glacier blue



glacier blue



TECHNOLOGY



VERSIONS



champagne gold

pepper green

honey yellow

light lavender

pistachio green

chestnut red

velvet black



graphite silver



polar white



signal silver



signal yellow

Ref. No.	Art. No.	EAN 4003318	Colour	Finish	Weight g	Size	Head size cm
Urban-I 4.0 ACE	10046197-01	46197 2	glacier blue	matt	260	S	51 - 55
Urban-I 4.0 ACE	10046198-01	46198 9	glacier blue	matt	280	M	54 - 58
Urban-I 4.0 ACE	10046199-01	46199 6	glacier blue	matt	300	L	57 - 61
Urban-I 4.0 ACE	10044890-01	44890 4	champagne gold	matt	260	S	51 - 55
Urban-I 4.0 ACE	10044899-01	44899 7	champagne gold	matt	280	M	54 - 58
Urban-I 4.0 ACE	10048935-01	48935 8	champagne gold	matt	300	L	57 - 61
Urban-I 4.0 ACE	10048936-01	48936 5	pepper green	matt	260	S	51 - 55
Urban-I 4.0 ACE	10044909-01	44909 3	pepper green	matt	280	M	54 - 58
Urban-I 4.0 ACE	10044910-01	44910 9	pepper green	matt	300	L	57 - 61
Urban-I 4.0 ACE	10044911-01	44911 6	honey yellow	matt	260	S	51 - 55
Urban-I 4.0 ACE	10044912-01	44912 3	honey yellow	matt	280	M	54 - 58
Urban-I 4.0 ACE	10044913-01	44913 0	honey yellow	matt	300	L	57 - 61
Urban-I 4.0 ACE	10044914-01	44914 7	light lavender	matt	260	S	51 - 55
Urban-I 4.0 ACE	10044917-01	44917 8	light lavender	matt	280	M	54 - 58
Urban-I 4.0 ACE	10044918-01	44918 5	light lavender	matt	300	L	57 - 61
Urban-I 4.0 ACE	10044919-01	44919 2	pistacchio green	matt	260	S	51 - 55
Urban-I 4.0 ACE	10044920-01	44920 8	pistacchio green	matt	280	M	54 - 58
Urban-I 4.0 ACE	10048979-01	48979 2	pistacchio green	matt	300	L	57 - 61
Urban-I 4.0 ACE	10046200-01	46200 9	chestnut red	matt	260	S	51 - 55
Urban-I 4.0 ACE	10046201-01	46201 6	chestnut red	matt	280	M	54 - 58
Urban-I 4.0 ACE	10046204-01	46204 7	chestnut red	matt	300	L	57 - 61
Urban-I 4.0 ACE	10044746-01	44746 4	velvet black	matt	260	S	51 - 55
Urban-I 4.0 ACE	10044747-01	44747 1	velvet black	matt	280	M	54 - 58
Urban-I 4.0 ACE	10044748-01	44748 8	velvet black	matt	300	L	57 - 61
Urban-I 4.0 ACE	10044749-01	44749 5	velvet black	matt	320	XL	60 - 64
Urban-I 4.0 ACE	10044751-01	44751 8	graphite silver	matt	260	S	51 - 55
Urban-I 4.0 ACE	10044755-01	44755 6	graphite silver	matt	280	M	54 - 58
Urban-I 4.0 ACE	10044761-01	44761 7	graphite silver	matt	300	L	57 - 61
Urban-I 4.0 ACE	10044771-01	44771 6	graphite silver	matt	320	XL	60 - 64
Urban-I 4.0 ACE	10044777-01	44777 8	polar white	matt	260	S	51 - 55
Urban-I 4.0 ACE	10044778-01	44778 5	polar white	matt	280	M	54 - 58
Urban-I 4.0 ACE	10044779-01	44779 2	polar white	matt	300	L	57 - 61
Urban-I 4.0 ACE	10044780-01	44780 8	polar white	matt	320	XL	60 - 64
Urban-I 4.0 ACE	10044772-01	44772 3	signal silver	matt + shiny	260	S	51 - 55
Urban-I 4.0 ACE	10044773-01	44773 0	signal silver	matt + shiny	280	M	54 - 58
Urban-I 4.0 ACE	10044775-01	44775 4	signal silver	matt + shiny	300	L	57 - 61
Urban-I 4.0 ACE	10044776-01	44776 1	signal silver	matt + shiny	320	XL	60 - 64
Urban-I 4.0 ACE	10044787-01	44787 7	signal yellow	matt + shiny	260	S	51 - 55
Urban-I 4.0 ACE	10044811-01	44811 9	signal yellow	matt + shiny	280	M	54 - 58
Urban-I 4.0 ACE	10044879-01	44879 9	signal yellow	matt + shiny	300	L	57 - 61
Urban-I 4.0 ACE	10044889-01	44889 8	signal yellow	matt + shiny	320	XL	60 - 64
ABUS Bag	10078592-01	78592 4	black			universal	

# URBAN-I 4.0

VIEWS



champagne gold



champagne gold



TECHNOLOGY



VERSIONS



pepper green

honey yellow

light lavender

pistachio green

glacier blue

chestnut red

graphite silver



velvet black



signal silver



shiny white



signal yellow

Ref. No.	Art. No.	EAN 4003318	Colour	Finish	Weight g	Size	Head size cm
Urban-I 4.0	10044968-01	44968 0	champagne gold	shiny	250	S	51 - 55
Urban-I 4.0	10044969-01	44969 7	champagne gold	shiny	270	M	54 - 58
Urban-I 4.0	10044970-01	44970 3	champagne gold	shiny	290	L	57 - 61
Urban-I 4.0	10044971-01	44971 0	pepper green	shiny	250	S	51 - 55
Urban-I 4.0	10044972-01	44972 7	pepper green	shiny	270	M	54 - 58
Urban-I 4.0	10044973-01	44973 4	pepper green	shiny	290	L	57 - 61
Urban-I 4.0	10044974-01	44974 1	honey yellow	shiny	250	S	51 - 55
Urban-I 4.0	10044975-01	44975 8	honey yellow	shiny	270	M	54 - 58
Urban-I 4.0	10044976-01	44976 5	honey yellow	shiny	290	L	57 - 61
Urban-I 4.0	10044977-01	44977 2	light lavender	shiny	250	S	51 - 55
Urban-I 4.0	10044978-01	44978 9	light lavender	shiny	270	M	54 - 58
Urban-I 4.0	10044979-01	44979 6	light lavender	shiny	290	L	57 - 61
Urban-I 4.0	10044980-01	44980 2	pistachio green	shiny	250	S	51 - 55
Urban-I 4.0	10044981-01	44981 9	pistachio green	shiny	270	M	54 - 58
Urban-I 4.0	10044982-01	44982 6	pistachio green	shiny	290	L	57 - 61
Urban-I 4.0	10046159-01	46159 0	glacier blue	shiny	250	S	51 - 55
Urban-I 4.0	10046161-01	46161 3	glacier blue	shiny	270	M	54 - 58
Urban-I 4.0	10046169-01	46169 9	glacier blue	shiny	290	L	57 - 61
Urban-I 4.0	10046189-01	46189 7	chestnut red	shiny	250	S	51 - 55
Urban-I 4.0	10046195-01	46195 8	chestnut red	shiny	270	M	54 - 58
Urban-I 4.0	10046196-01	46196 5	chestnut red	shiny	290	L	57 - 61
Urban-I 4.0	10044945-01	44945 1	graphite silver	shiny	250	S	51 - 55
Urban-I 4.0	10044949-01	44949 9	graphite silver	shiny	270	M	54 - 58
Urban-I 4.0	10044950-01	44950 5	graphite silver	shiny	290	L	57 - 61
Urban-I 4.0	10044951-01	44951 2	graphite silver	shiny	310	XL	60 - 64
Urban-I 4.0	10044940-01	44940 6	velvet black	matt	250	S	51 - 55
Urban-I 4.0	10044941-01	44941 3	velvet black	matt	270	M	54 - 58
Urban-I 4.0	10044942-01	44942 0	velvet black	matt	290	L	57 - 61
Urban-I 4.0	10044944-01	44944 4	velvet black	matt	310	XL	60 - 64
Urban-I 4.0	10044952-01	44952 9	signal silver	shiny	250	S	51 - 55
Urban-I 4.0	10044953-01	44953 6	signal silver	shiny	270	M	54 - 58
Urban-I 4.0	10044954-01	44954 3	signal silver	shiny	290	L	57 - 61
Urban-I 4.0	10044955-01	44955 0	signal silver	shiny	310	XL	60 - 64
Urban-I 4.0	10044957-01	44957 4	shiny white	shiny	250	S	51 - 55
Urban-I 4.0	10044958-01	44958 1	shiny white	shiny	270	M	54 - 58
Urban-I 4.0	10044959-01	44959 8	shiny white	shiny	290	L	57 - 61
Urban-I 4.0	10044960-01	44960 4	shiny white	shiny	310	XL	60 - 64
Urban-I 4.0	10044961-01	44961 1	signal yellow	shiny	250	S	51 - 55
Urban-I 4.0	10044962-01	44962 8	signal yellow	shiny	270	M	54 - 58
Urban-I 4.0	10044965-01	44965 9	signal yellow	shiny	290	L	57 - 61
Urban-I 4.0	10044966-01	44966 6	signal yellow	shiny	310	XL	60 - 64
ABUS Bag	10078592-01	78592 4	black			universal	

# URBAN-I 4.0 LR

## VIEWS



signal silver



signal silver



## TECHNOLOGY



## VERSIONS



velvet black

Ref. No.	Art. No.	EAN 4003318	Colour	Finish	Weight g	Size	Head size cm
Urban-I 4.0 LR	10044984-01	44984 0	signal silver	shiny	240	S	51 - 55
Urban-I 4.0 LR	10044985-01	44985 7	signal silver	shiny	260	M	54 - 58
Urban-I 4.0 LR	10044986-01	44986 4	signal silver	shiny	280	L	57 - 61
Urban-I 4.0 LR	10044987-01	44987 1	signal silver	shiny	300	XL	60 - 64
Urban-I 4.0 LR	10044988-01	44988 8	velvet black	matt	240	S	51 - 55
Urban-I 4.0 LR	10044989-01	44989 5	velvet black	matt	260	M	54 - 58
Urban-I 4.0 LR	10044990-01	44990 1	velvet black	matt	280	L	57 - 61
Urban-I 4.0 LR	10044991-01	44991 8	velvet black	matt	300	XL	60 - 64
Rear light Urban-I 4.0/Taipan	10047268-01	47268 8	black			universal	
Rear light ACE Urban-I 4.0/Taipan	10047269-01	47269 5	black			universal	
ABUS Bag	10078592-01	78592 4	black			universal	

# PURL-Y ACE

## VIEWS



mint green



mint green



## TECHNOLOGY



NTA 8776

## VERSIONS



light lavender



velvet black



titan



polar white



metallic copper



midnight blue



moss green



champagne gold



iced blue



signal yellow

Ref. No.	Art. No.	EAN 4003318	Colour	Finish	Weight g	Size	Head size cm
PURL-Y ACE	10038078-01	38078 5	mint green	matt + shiny	320	S	51 - 55
PURL-Y ACE	10094337-01	94337 9	mint green	matt + shiny	340	M	54 - 58
PURL-Y ACE	10040963-01	40963 9	mint green	matt + shiny	360	L	57 - 61
PURL-Y ACE	10094338-01	94338 6	light lavender	matt + shiny	320	S	51 - 55
PURL-Y ACE	10040964-01	40964 6	light lavender	matt + shiny	340	M	54 - 58
PURL-Y ACE	10040446-01	40446 7	light lavender	matt + shiny	360	L	57 - 61
PURL-Y ACE	10097904-01	97904 0	velvet black	matt + shiny	320	S	51 - 55
PURL-Y ACE	10097905-01	97905 7	velvet black	matt + shiny	340	M	54 - 58
PURL-Y ACE	10097906-01	97906 4	velvet black	matt + shiny	360	L	57 - 61
PURL-Y ACE	10097907-01	97907 1	titan	matt + shiny	320	S	51 - 55
PURL-Y ACE	10097908-01	97908 8	titan	matt + shiny	340	M	54 - 58
PURL-Y ACE	10097909-01	97909 5	titan	matt + shiny	360	L	57 - 61
PURL-Y ACE	10097910-01	97910 1	polar white	matt + shiny	320	S	51 - 55
PURL-Y ACE	10097912-01	97912 5	polar white	matt + shiny	340	M	54 - 58
PURL-Y ACE	10097913-01	97913 2	polar white	matt + shiny	360	L	57 - 61
PURL-Y ACE	10097914-01	97914 9	metallic copper	matt + shiny	320	S	51 - 55
PURL-Y ACE	10097915-01	97915 6	metallic copper	matt + shiny	340	M	54 - 58
PURL-Y ACE	10097916-01	97916 3	metallic copper	matt + shiny	360	L	57 - 61
PURL-Y ACE	10097917-01	97917 0	midnight blue	matt + shiny	320	S	51 - 55
PURL-Y ACE	10097918-01	97918 7	midnight blue	matt + shiny	340	M	54 - 58
PURL-Y ACE	10097919-01	97919 4	midnight blue	matt + shiny	360	L	57 - 61
PURL-Y ACE	10097920-01	97920 0	moss green	matt + shiny	320	S	51 - 55
PURL-Y ACE	10097921-01	97921 7	moss green	matt + shiny	340	M	54 - 58
PURL-Y ACE	10097922-01	97922 4	moss green	matt + shiny	360	L	57 - 61
PURL-Y ACE	10097926-01	97926 2	champagne gold	matt + shiny	320	S	51 - 55
PURL-Y ACE	10097927-01	97927 9	champagne gold	matt + shiny	340	M	54 - 58
PURL-Y ACE	10097928-01	97928 6	champagne gold	matt + shiny	360	L	57 - 61
PURL-Y ACE	10097923-01	97923 1	iced blue	matt + shiny	320	S	51 - 55
PURL-Y ACE	10097924-01	97924 8	iced blue	matt + shiny	340	M	54 - 58
PURL-Y ACE	10097925-01	97925 5	iced blue	matt + shiny	360	L	57 - 61
PURL-Y ACE	10097929-01	97929 3	signal yellow	matt + shiny	320	S	51 - 55
PURL-Y ACE	10097930-01	97930 9	signal yellow	matt + shiny	340	M	54 - 58
PURL-Y ACE	10097931-01	97931 6	signal yellow	matt + shiny	360	L	57 - 61
ABUS Bag	10078592-01	78592 4	black			universal	



# PURL-Y

## VIEWS



light lavender



light lavender



## TECHNOLOGY



## VERSIONS



mint green



shiny black



titan



shiny white



metallic copper



midnight blue



moss green



champagne gold



iced blue



signal yellow

Ref. No.	Art. No.	EAN 4003318	Colour	Finish	Weight g	Size	Head size cm
PURL-Y	10040445-01	40445 0	light lavender	matt + shiny	300	S	51 - 55
PURL-Y	10038077-01	38077 8	light lavender	matt + shiny	320	M	54 - 58
PURL-Y	10094336-01	94336 2	light lavender	matt + shiny	340	L	57 - 61
PURL-Y	10040962-01	40962 2	mint green	matt + shiny	300	S	51 - 55
PURL-Y	10040444-01	40444 3	mint green	matt + shiny	320	M	54 - 58
PURL-Y	10038076-01	38076 1	mint green	matt + shiny	340	L	57 - 61
PURL-Y	10097850-01	97850 0	shiny black	shiny	300	S	51 - 55
PURL-Y	10097878-01	97878 4	shiny black	shiny	320	M	54 - 58
PURL-Y	10097879-01	97879 1	shiny black	shiny	340	L	57 - 61
PURL-Y	10097880-01	97880 7	titan	shiny	300	S	51 - 55
PURL-Y	10097881-01	97881 4	titan	shiny	320	M	54 - 58
PURL-Y	10097882-01	97882 1	titan	shiny	340	L	57 - 61
PURL-Y	10097883-01	97883 8	shiny white	shiny	300	S	51 - 55
PURL-Y	10097884-01	97884 5	shiny white	shiny	320	M	54 - 58
PURL-Y	10097885-01	97885 2	shiny white	shiny	340	L	57 - 61
PURL-Y	10097886-01	97886 9	metallic copper	shiny	300	S	51 - 55
PURL-Y	10097887-01	97887 6	metallic copper	shiny	320	M	54 - 58
PURL-Y	10097888-01	97888 3	metallic copper	shiny	340	L	57 - 61
PURL-Y	10097889-01	97889 0	midnight blue	shiny	300	S	51 - 55
PURL-Y	10097890-01	97890 6	midnight blue	shiny	320	M	54 - 58
PURL-Y	10097891-01	97891 3	midnight blue	shiny	340	L	57 - 61
PURL-Y	10097892-01	97892 0	moss green	shiny	300	S	51 - 55
PURL-Y	10097893-01	97893 7	moss green	shiny	320	M	54 - 58
PURL-Y	10097894-01	97894 4	moss green	shiny	340	L	57 - 61
PURL-Y	10097898-01	97898 2	champagne gold	shiny	300	S	51 - 55
PURL-Y	10097899-01	97899 9	champagne gold	shiny	320	M	54 - 58
PURL-Y	10097900-01	97900 2	champagne gold	shiny	340	L	57 - 61
PURL-Y	10097895-01	97895 1	iced blue	shiny	300	S	51 - 55
PURL-Y	10097896-01	97896 8	iced blue	shiny	320	M	54 - 58
PURL-Y	10097897-01	97897 5	iced blue	shiny	340	L	57 - 61
PURL-Y	10097901-01	97901 9	signal yellow	shiny	300	S	51 - 55
PURL-Y	10097902-01	97902 6	signal yellow	shiny	320	M	54 - 58
PURL-Y	10097903-01	97903 3	signal yellow	shiny	340	L	57 - 61
Rear light HUD-Y (ACE)/PURL-Y (ACE)	10069446-01	69446 2	black		20	universal	
ABUS Bag	10078592-01	78592 4	black			universal	

Urban



# HYBAN 2.0 ACE

## VIEWS



titan



titan



## TECHNOLOGY



## VERSIONS



velvet black



signal yellow



polar white

Ref. No.	Art. No.	EAN 4003318	Colour	Finish	Weight g	Size	Head size cm
Hyban 2.0 ACE	10086937-01	86937 2	titan	matt	470	M	52 - 58
Hyban 2.0 ACE	10086938-01	86938 9	titan	matt	510	L	56 - 61
Hyban 2.0 ACE	10086939-01	86939 6	titan	matt	560	XL	58 - 63
Hyban 2.0 ACE	10086934-01	86934 1	velvet black	matt	470	M	52 - 58
Hyban 2.0 ACE	10086935-01	86935 8	velvet black	matt	510	L	56 - 61
Hyban 2.0 ACE	10086936-01	86936 5	velvet black	matt	560	XL	58 - 63
Hyban 2.0 ACE	10086940-01	86940 2	signal yellow	shiny	470	M	52 - 58
Hyban 2.0 ACE	10086941-01	86941 9	signal yellow	shiny	510	L	56 - 61
Hyban 2.0 ACE	10086997-01	86997 6	polar white	shiny	470	M	52 - 58
Hyban 2.0 ACE	10086998-01	86998 3	polar white	shiny	510	L	56 - 61
Visor Pedelec 2.0 Hyban 2.0/HUD-Y	10082888-01	82888 1	smoke			universal	
Visor Pedelec 2.0 Hyban 2.0/HUD-Y	10082889-01	82889 8	clear			universal	
Winter Kit	10048876-01	48876 4	black			M	
Winter Kit	10048877-01	48877 1	black			L	
ABUS Bag	10078592-01	78592 4	black			universal	



# HYBAN 2.0

## VIEWS



chrome silver



chrome silver



## TECHNOLOGY



## VERSIONS



velvet black



titan



polar white



glacier blue



core green



core blue



chrome rosé



Mips

velvet black



Mips

titan



Mips

signal yellow

Ref. No.	Art. No.	EAN 4003318	Colour	Finish	Weight g	Size	Head size cm
Hyban 2.0	10040184-01	40184 8	chrome silver	shiny	400	M	52 - 58
Hyban 2.0	10040197-01	40197 8	chrome silver	shiny	460	L	56 - 61
Hyban 2.0	10040185-01	40185 5	chrome rosé	shiny	400	M	52 - 58
Hyban 2.0	10086899-01	86899 3	velvet black	matt	400	M	52 - 58
Hyban 2.0	10086900-01	86900 6	velvet black	matt	460	L	56 - 61
Hyban 2.0	10086901-01	86901 3	velvet black	matt	500	XL	58 - 63
Hyban 2.0	10086905-01	86905 1	titan	matt	400	M	52 - 58
Hyban 2.0	10086906-01	86906 8	titan	matt	460	L	56 - 61
Hyban 2.0	10086907-01	86907 5	titan	matt	500	XL	58 - 63
Hyban 2.0	10086902-01	86902 0	polar white	shiny	400	M	52 - 58
Hyban 2.0	10086903-01	86903 7	polar white	shiny	460	L	56 - 61
Hyban 2.0	10086904-01	86904 4	polar white	shiny	500	XL	58 - 63
Hyban 2.0	10086929-01	86929 7	glacier blue	shiny	400	M	52 - 58
Hyban 2.0	10086930-01	86930 3	glacier blue	shiny	460	L	56 - 61
Hyban 2.0	10086920-01	86920 4	core green	shiny	400	M	52 - 58
Hyban 2.0	10086921-01	86921 1	core green	shiny	460	L	56 - 61
Hyban 2.0	10086917-01	86917 4	core blue	shiny	400	M	52 - 58
Hyban 2.0	10086918-01	86918 1	core blue	shiny	460	L	56 - 61
Hyban 2.0	10086914-01	86914 3	signal silver	shiny	400	M	52 - 58
Hyban 2.0	10086915-01	86915 0	signal silver	shiny	460	L	56 - 61
Hyban 2.0	10086916-01	86916 7	signal silver	shiny	500	XL	58 - 63
Hyban 2.0	10086908-01	86908 2	signal yellow	shiny	400	M	52 - 58
Hyban 2.0	10086909-01	86909 9	signal yellow	shiny	460	L	56 - 61
Hyban 2.0 MIPS	10089200-01	89200 4	velvet black	matt	420	M	52 - 58
Hyban 2.0 MIPS	10089199-01	89199 1	velvet black	matt	480	L	56 - 61
Hyban 2.0 MIPS	10089203-01	89203 5	titan	matt	420	M	52 - 58
Hyban 2.0 MIPS	10089202-01	89202 8	titan	matt	480	L	56 - 61
Hyban 2.0 MIPS	10089204-01	89204 2	titan	matt	500	XL	58 - 63
Hyban 2.0 MIPS	10089206-01	89206 6	signal yellow	shiny	420	M	52 - 58
Hyban 2.0 MIPS	10089205-01	89205 9	signal yellow	shiny	480	L	56 - 61
Hyban 2.0 MIPS	10089207-01	89207 3	signal yellow	shiny	500	XL	58 - 63
Winter Kit	10048876-01	48876 4	black			M	
Winter Kit	10048877-01	48877 1	black			L	
ABUS Bag	10078592-01	78592 4	black			universal	



# XOXO

NEW

## VIEWS



mono red



mono red



## TECHNOLOGY



## VERSIONS



mono yellow



mono blue



mono orange



strawberry rose



cool grey



mint green



aqua blue



polar white



velvet black



birch taupe

Ref. No.	Art. No.	EAN 4003318	Colour	Finish	Weight g	Size	Head size cm
XOXO	10045063-01	45063 1	mono red	matt	370	S	51 - 55
XOXO	10049410-01	49410 9	mono red	matt	400	M	54 - 58
XOXO	10049416-01	49416 1	mono red	matt	440	L	57 - 61
XOXO	10045066-01	45066 2	mono yellow	matt	370	S	51 - 55
XOXO	10045067-01	45067 9	mono yellow	matt	400	M	54 - 58
XOXO	10045068-01	45068 6	mono yellow	matt	440	L	57 - 61
XOXO	10045069-01	45069 3	mono blue	matt	370	S	51 - 55
XOXO	10045070-01	45070 9	mono blue	matt	400	M	54 - 58
XOXO	10045071-01	45071 6	mono blue	matt	440	L	57 - 61
XOXO	10045072-01	45072 3	mono orange	matt	370	S	51 - 55
XOXO	10045073-01	45073 0	mono orange	matt	400	M	54 - 58
XOXO	10045074-01	45074 7	mono orange	matt	440	L	57 - 61
XOXO	10045075-01	45075 4	strawberry rose	matt	370	S	51 - 55
XOXO	10045076-01	45076 1	strawberry rose	matt	400	M	54 - 58
XOXO	10045077-01	45077 8	strawberry rose	matt	440	L	57 - 61
XOXO	10045079-01	45079 2	cool grey	matt	370	S	51 - 55
XOXO	10045080-01	45080 8	cool grey	matt	400	M	54 - 58
XOXO	10045081-01	45081 5	cool grey	matt	440	L	57 - 61
XOXO	10038052-01	38052 5	mint green	matt	370	S	51 - 55
XOXO	10040421-01	40421 4	mint green	matt	400	M	54 - 58
XOXO	10040938-01	40938 7	mint green	matt	440	L	57 - 61
XOXO	10094313-01	94313 3	aqua blue	matt	370	S	51 - 55
XOXO	10038053-01	38053 2	aqua blue	matt	400	M	54 - 58
XOXO	10040422-01	40422 1	aqua blue	matt	440	L	57 - 61
XOXO	10040420-01	40420 7	polar white	matt	370	S	51 - 55
XOXO	10040937-01	40937 0	polar white	matt	400	M	54 - 58
XOXO	10094312-01	94312 6	polar white	matt	440	L	57 - 61
XOXO	10040936-01	40936 3	velvet black	matt	370	S	51 - 55
XOXO	10094311-01	94311 9	velvet black	matt	400	M	54 - 58
XOXO	10038051-01	38051 8	velvet black	matt	440	L	57 - 61
XOXO ECO	10038156-01	38156 0	birch taupe	matt	370	S	51 - 55
XOXO ECO	10094423-01	94423 9	birch taupe	matt	400	M	54 - 58
XOXO ECO	10041040-01	41040 6	birch taupe	matt	440	L	57 - 61

# SKURB ACE

## VIEWS



goldfish orange



goldfish orange



## TECHNOLOGY



## VERSIONS



moss green



velvet black



silver white

Ref. No.	Art. No.	EAN 4003318	Colour	Finish	Weight g	Size	Head size cm
Skurb Ace	10097963-01	97963 7	goldfish orange	shiny	300	S	52 - 56
Skurb Ace	10097964-01	97964 4	goldfish orange	shiny	310	M	55 - 59
Skurb Ace	10097965-01	97965 1	goldfish orange	shiny	340	L	58 - 61
Skurb Ace	10097967-01	97967 5	moss green	shiny	300	S	52 - 56
Skurb Ace	10097968-01	97968 2	moss green	shiny	310	M	55 - 59
Skurb Ace	10097969-01	97969 9	moss green	shiny	340	L	58 - 61
Skurb ACE	10040385-01	40385 9	velvet black	matt + shiny	310	S	52 - 56
Skurb ACE	10040386-01	40386 6	velvet black	matt + shiny	320	M	55 - 59
Skurb ACE	10040387-01	40387 3	velvet black	matt + shiny	340	L	58 - 61
Skurb ACE	10040394-01	40394 1	silver white	matt + shiny	310	S	52 - 56
Skurb ACE	10040395-01	40395 8	silver white	matt + shiny	320	M	55 - 59
Skurb ACE	10040396-01	40396 5	silver white	matt + shiny	340	L	58 - 61



# SKURB

## VIEWS



goldfish orange



goldfish orange



## TECHNOLOGY



## VERSIONS



moss green



velvet black



titan



pearl white



midnight blue

Ref. No.	Art. No.	EAN 4003318	Colour	Finish	Weight g	Size	Head size cm
Skurb	10097957-01	97957 6	goldfish orange	shiny	300	S	52 - 56
Skurb	10097958-01	97958 3	goldfish orange	shiny	310	M	55 - 59
Skurb	10097959-01	97959 0	goldfish orange	shiny	340	L	58 - 61
Skurb	10097960-01	97960 6	moss green	shiny	300	S	52 - 56
Skurb	10097961-01	97961 3	moss green	shiny	310	M	55 - 59
Skurb	10097962-01	97962 0	moss green	shiny	340	L	58 - 61
Skurb	10040367-01	40367 5	velvet black	matt	300	S	52 - 56
Skurb	10040368-01	40368 2	velvet black	matt	310	M	55 - 59
Skurb	10040369-01	40369 9	velvet black	matt	340	L	58 - 61
Skurb	10040370-01	40370 5	titan	matt	300	S	52 - 56
Skurb	10040371-01	40371 2	titan	matt	310	M	55 - 59
Skurb	10040372-01	40372 9	titan	matt	340	L	58 - 61
Skurb	10040373-01	40373 6	pearl white	shiny	300	S	52 - 56
Skurb	10040374-01	40374 3	pearl white	shiny	310	M	55 - 59
Skurb	10040375-01	40375 0	pearl white	shiny	340	L	58 - 61
Skurb	10040376-01	40376 7	midnight blue	shiny	300	S	52 - 56
Skurb	10040377-01	40377 4	midnight blue	shiny	310	M	55 - 59
Skurb	10040378-01	40378 1	midnight blue	shiny	340	L	58 - 61



# ADURO 3.0 LED

IEWS



velvet black



velvet black



TECHNOLOGY



VERSIONS



polar white    midnight blue    titan    race black    glacier blue    blaze red    race grey



maori blackberry    white art    orange palm    purple waves    signal yellow

Ref. No.	Art. No.	EAN 4003318	Colour	Finish	Weight g	Size	Head size cm
Aduro 3.0 LED	10094637-01	94637 0	velvet black	matt	295	S	51 - 55
Aduro 3.0 LED	10041242-01	41242 4	velvet black	matt	315	M	52 - 58
Aduro 3.0 LED	10038348-01	38348 9	velvet black	matt	335	L	58 - 62
Aduro 3.0 LED	10038354-01	38354 0	polar white	matt	295	S	51 - 55
Aduro 3.0 LED	10041249-01	41249 3	polar white	matt	315	M	52 - 58
Aduro 3.0 LED	10094644-01	94644 8	polar white	matt	335	L	58 - 62
Aduro 3.0 LED	10038356-01	38356 4	midnight blue	shiny	295	S	51 - 55
Aduro 3.0 LED	10041251-01	41251 6	midnight blue	shiny	315	M	52 - 58
Aduro 3.0 LED	10094646-01	94646 2	midnight blue	shiny	335	L	58 - 62
Aduro 3.0 LED	10041244-01	41244 8	titan	matt	295	S	51 - 55
Aduro 3.0 LED	10094639-01	94639 4	titan	matt	315	M	52 - 58
Aduro 3.0 LED	10038350-01	38350 2	titan	matt	335	L	58 - 62
Aduro 3.0 LED	10041247-01	41247 9	race black	matt	295	S	51 - 55
Aduro 3.0 LED	10041255-01	41255 4	race black	matt	315	M	52 - 58
Aduro 3.0 LED	10094642-01	94642 4	race black	matt	335	L	58 - 62
Aduro 3.0 LED	10038358-01	38358 8	glacier blue	shiny	295	S	51 - 55
Aduro 3.0 LED	10041253-01	41253 0	glacier blue	shiny	315	M	52 - 58
Aduro 3.0 LED	10038359-01	38359 5	glacier blue	shiny	335	L	58 - 62
Aduro 3.0 LED	10041254-01	41254 7	blaze red	shiny	295	S	51 - 55
Aduro 3.0 LED	10094648-01	94648 6	blaze red	shiny	315	M	52 - 58
Aduro 3.0 LED	10038360-01	38360 1	blaze red	shiny	335	L	58 - 62
Aduro 3.0 LED	10041246-01	41246 2	race grey	matt	295	S	51 - 55
Aduro 3.0 LED	10094641-01	94641 7	race grey	matt	315	M	52 - 58
Aduro 3.0 LED	10038352-01	38352 6	race grey	matt	335	L	58 - 62
Aduro 3.0 LED	10038357-01	38357 1	maori blackberry	matt	295	S	51 - 55
Aduro 3.0 LED	10041252-01	41252 3	maori blackberry	matt	315	M	52 - 58
Aduro 3.0 LED	10094647-01	94647 9	maori blackberry	matt	335	L	58 - 62
Aduro 3.0 LED	10041243-01	41243 1	white art	shiny	295	S	51 - 55
Aduro 3.0 LED	10094638-01	94638 7	white art	shiny	315	M	52 - 58
Aduro 3.0 LED	10038349-01	38349 6	white art	shiny	335	L	58 - 62
Aduro 3.0 LED	10038355-01	38355 7	orange palm	shiny	295	S	51 - 55
Aduro 3.0 LED	10041250-01	41250 9	orange palm	shiny	315	M	52 - 58
Aduro 3.0 LED	10094645-01	94645 5	orange palm	shiny	335	L	58 - 62
Aduro 3.0 LED	10038353-01	38353 3	purple waves	shiny	295	S	51 - 55
Aduro 3.0 LED	10041248-01	41248 6	purple waves	shiny	315	M	52 - 58
Aduro 3.0 LED	10094643-01	94643 1	purple waves	shiny	335	L	58 - 62
Aduro 3.0 LED	10041245-01	41245 5	signal yellow	shiny	295	S	51 - 55
Aduro 3.0 LED	10094640-01	94640 0	signal yellow	shiny	315	M	52 - 58
Aduro 3.0 LED	10038351-01	38351 9	signal yellow	shiny	335	L	58 - 62
ABUS Bag	10078592-01	78592 4	black			universal	

Urban



# ADURO 3.0

## VIEWS



purple waves



purple waves



## TECHNOLOGY



## VERSIONS



velvet black

polar white

midnight blue

titan

race black

glacier blue

blaze red



race grey

maori blackberry

white art

orange palm

signal yellow

Ref. No.	Art. No.	EAN 4003318	Colour	Finish	Weight g	Size	Head size cm
Aduro 3.0	10002098-01	02098 8	purple waves	shiny	280	S	51 - 55
Aduro 3.0	10002122-01	02122 0	purple waves	shiny	300	M	52 - 58
Aduro 3.0	10002123-01	02123 7	purple waves	shiny	320	L	58 - 62
Aduro 3.0	10090127-01	90127 0	velvet black	matt	280	S	51 - 55
Aduro 3.0	10090325-01	90325 0	velvet black	matt	300	M	52 - 58
Aduro 3.0	10090346-01	90346 5	velvet black	matt	320	L	58 - 62
Aduro 3.0	10090493-01	90493 6	polar white	matt	280	S	51 - 55
Aduro 3.0	10090628-01	90628 2	polar white	matt	300	M	52 - 58
Aduro 3.0	10090793-01	90793 7	polar white	matt	320	L	58 - 62
Aduro 3.0	10091265-01	91265 8	midnight blue	shiny	280	S	51 - 55
Aduro 3.0	10091268-01	91268 9	midnight blue	shiny	300	M	52 - 58
Aduro 3.0	10091269-01	91269 6	midnight blue	shiny	320	L	58 - 62
Aduro 3.0	10091270-01	91270 2	titan	matt	280	S	51 - 55
Aduro 3.0	10091273-01	91273 3	titan	matt	300	M	52 - 58
Aduro 3.0	10091277-01	91277 1	titan	matt	320	L	58 - 62
Aduro 3.0	10091280-01	91280 1	race black	matt	280	S	51 - 55
Aduro 3.0	10091281-01	91281 8	race black	matt	300	M	52 - 58
Aduro 3.0	10091282-01	91282 5	race black	matt	320	L	58 - 62
Aduro 3.0	10091285-01	91285 6	glacier blue	shiny	280	S	51 - 55
Aduro 3.0	10091311-01	91311 2	glacier blue	shiny	300	M	52 - 58
Aduro 3.0	10091380-01	91380 8	glacier blue	shiny	320	L	58 - 62
Aduro 3.0	10091381-01	91381 5	blaze red	shiny	280	S	51 - 55
Aduro 3.0	10091528-01	91528 4	blaze red	shiny	300	M	52 - 58
Aduro 3.0	10091715-01	91715 8	blaze red	shiny	320	L	58 - 62
Aduro 3.0	10091732-01	91732 5	race grey	matt	280	S	51 - 55
Aduro 3.0	10091733-01	91733 2	race grey	matt	300	M	52 - 58
Aduro 3.0	10091734-01	91734 9	race grey	matt	320	L	58 - 62
Aduro 3.0	10091735-01	91735 6	maori blackberry	matt	280	S	51 - 55
Aduro 3.0	10091736-01	91736 3	maori blackberry	matt	300	M	52 - 58
Aduro 3.0	10091737-01	91737 0	maori blackberry	matt	320	L	58 - 62
Aduro 3.0	10091738-01	91738 7	white art	shiny	280	S	51 - 55
Aduro 3.0	10091739-01	91739 4	white art	shiny	300	M	52 - 58
Aduro 3.0	10091740-01	91740 0	white art	shiny	320	L	58 - 62
Aduro 3.0	10002033-01	02033 9	orange palm	shiny	280	S	51 - 55
Aduro 3.0	10002044-01	02044 5	orange palm	shiny	300	M	52 - 58
Aduro 3.0	10002095-01	02095 7	orange palm	shiny	320	L	58 - 62
Aduro 3.0	10002549-01	02549 5	signal yellow	shiny	280	S	51 - 55
Aduro 3.0	10002794-01	02794 9	signal yellow	shiny	300	M	52 - 58
Aduro 3.0	10002850-01	02850 2	signal yellow	shiny	320	L	58 - 62
Rear light Aduro 3.0	10002939-01	02939 4	black		20	universal	
ABUS Bag	10078592-01	78592 4	black			universal	



**KIDS**



**YOUDROP FF**



Page 244

**YOUN-I 2.0**



Page 246

**YOUN-I MIPS**



Page 248

**SKURB KID**



Page 250

**SMILEY 3.0 ACE LED**



Page 252

**SMILEY 3.0 LED**



Page 254

**SMILEY 3.0**



Page 256





**SMOOTY 2.0**



Page 258

Kids

# PRODUCT FEATURE MATRIX KIDS

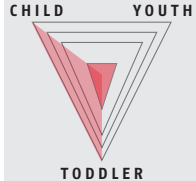
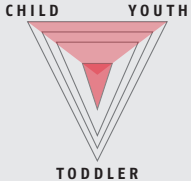
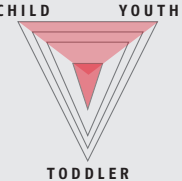
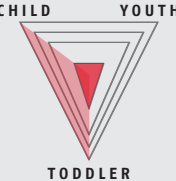
	YOUDROPFF	YOUN-12.0	YOUN-1MIPS	SKURBKID
				
<b>AGE RECOMMENDATION</b>	 <p>CHILD YOUTH TODDLER</p>	 <p>CHILD YOUTH TODDLER</p>	 <p>CHILD YOUTH TODDLER</p>	 <p>CHILD YOUTH TODDLER</p>
<b>REAR LIGHT</b>	-	✓	✓	Optional
<b>RECHARGABLE BATTERY</b>	-	Optional	-	Optional
<b>REFLECTOR STICKER</b>	✓	✓	✓	-
<b>BUCKLE</b>	Push-In Buckle	Push-In Buckle	Push-In Buckle	Push-In Buckle
<b>PONYTAIL FIT</b>	✓	✓	✓	✓
<b>MIPS</b>	-	-	✓	-
<b>BUG MESH</b>	✓	✓	✓	-
<b>LOWER SHELL</b>	-	-	-	-
<b>WEIGHT (Size S)</b>	430g	240g	260g	240g
<b>SIZE RUN</b>	S 48 - 55 cm	S 48 - 54 cm M 52 - 57 cm	S 48 - 54 cm M 52 - 57 cm	S 45 - 50 cm M 50 - 55 cm

SMILEY 3.0

SMOOTY 2.0



AGE RECOMMENDATION

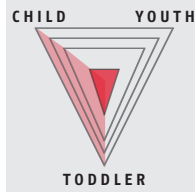
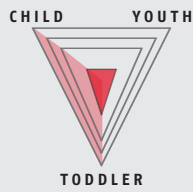

	ACE	LED	Basic	
REAR LIGHT	✓	✓	Optional	-
RECHARGABLE BATTERY	✓	Optional	Optional	-
REFLECTOR STICKER		✓		✓
BUCKLE	Push-In Buckle		Push-In Buckle	
PONYTAIL FIT		✓		-
MIPS		-		-
BUG MESH		✓		✓
LOWER SHELL	✓	-	-	-
WEIGHT (Size S)	230 g	230 g	220 g	200 g
SIZE RUN	S 45 - 50 cm M 50 - 55 cm		S 45 - 50 cm M 50 - 55 cm	

# YOUDROP FF

## VIEWS



Ti silver



Ti silver



## TECHNOLOGY



## VERSIONS



moss green



sage green



velvet black



midnight blue

Ref. No.	Art. No.	EAN 4003318	Colour	Finish	Weight g	Size	Head size cm
YouDrop FF	10098089-01	98089 3	Ti silver	matt	430	S	48 - 55
YouDrop FF	10098090-01	98090 9	moss green	matt	430	S	48 - 55
YouDrop FF	10003421-01	03421 3	sage green	matt	430	S	48 - 55
YouDrop FF	10003419-01	03419 0	velvet black	matt	430	S	48 - 55
YouDrop FF	10003420-01	03420 6	midnight blue	matt	430	S	48 - 55



# YOUN-I 2.0

## VIEWS



mono red



mono red



## TECHNOLOGY



## VERSIONS



Ref. No.	Art. No.	EAN 4003318	Colour	Finish	Weight g	Size	Head size cm
Youn-I 2.0	10045223-01	45223 9	mono red	matt	240	S	48 - 54
Youn-I 2.0	10045224-01	45224 6	mono red	matt	260	M	52 - 57
Youn-I 2.0	10045228-01	45228 4	mono yellow	matt	240	S	48 - 54
Youn-I 2.0	10045317-01	45317 5	mono yellow	matt	260	M	52 - 57
Youn-I 2.0	10045354-01	45354 0	mono blue	matt	240	S	48 - 54
Youn-I 2.0	10045360-01	45360 1	mono blue	matt	260	M	52 - 57
Youn-I 2.0	10049417-01	49417 8	mono orange	matt	240	S	48 - 54
Youn-I 2.0	10045438-01	45438 7	mono orange	matt	260	M	52 - 57
Youn-I 2.0	10045440-01	45440 0	champagne gold	matt	240	S	48 - 54
Youn-I 2.0	10045441-01	45441 7	champagne gold	matt	260	M	52 - 57
Youn-I 2.0	10045442-01	45442 4	graphite silver	matt	240	S	48 - 54
Youn-I 2.0	10045443-01	45443 1	graphite silver	matt	260	M	52 - 57
Youn-I 2.0	10091890-01	91890 2	cool grey	matt	240	S	48 - 54
Youn-I 2.0	10091891-01	91891 9	cool grey	matt	260	M	52 - 57
Youn-I 2.0	10040150-01	40150 3	velvet black	matt	240	S	48 - 54
Youn-I 2.0	10040151-01	40151 0	velvet black	matt	260	M	52 - 57
Youn-I 2.0	10040170-01	40170 1	sparkling titan	shiny	240	S	48 - 54
Youn-I 2.0	10040171-01	40171 8	sparkling titan	shiny	260	M	52 - 57
Youn-I 2.0	10040164-01	40164 0	sparkling pink	shiny	240	S	48 - 54
Youn-I 2.0	10040165-01	40165 7	sparkling pink	shiny	260	M	52 - 57
Youn-I 2.0	10040160-01	40160 2	sparkling green	shiny	240	S	48 - 54
Youn-I 2.0	10040161-01	40161 9	sparkling green	shiny	260	M	52 - 57
Youn-I 2.0	10040158-01	40158 9	sparkling blue	shiny	240	S	48 - 54
Youn-I 2.0	10040159-01	40159 6	sparkling blue	shiny	260	M	52 - 57
Youn-I 2.0	10040162-01	40162 6	signal yellow	shiny	240	S	48 - 54
Youn-I 2.0	10040163-01	40163 3	signal yellow	shiny	260	M	52 - 57
Youn-I 2.0	10040152-01	40152 7	pearl white	shiny	240	S	48 - 54
Youn-I 2.0	10040153-01	40153 4	pearl white	shiny	260	M	52 - 57
Youn-I 2.0	10040156-01	40156 5	living coral	shiny	240	S	48 - 54
Youn-I 2.0	10040157-01	40157 2	living coral	shiny	260	M	52 - 57
Youn-I 2.0	10063812-01	63812 1	grey flash	matt + shiny	240	S	48 - 54
Youn-I 2.0	10063813-01	63813 8	grey flash	matt + shiny	260	M	52 - 57
Youn-I 2.0	10040154-01	40154 1	glacier blue	shiny	240	S	48 - 54
Youn-I 2.0	10040155-01	40155 8	glacier blue	shiny	260	M	52 - 57
Youn-I 2.0	10063808-01	63808 4	cherry heart	matt + shiny	240	S	48 - 54
Youn-I 2.0	10063809-01	63809 1	cherry heart	matt + shiny	260	M	52 - 57
Youn-I 2.0	10040168-01	40168 8	blaze red	shiny	240	S	48 - 54
Youn-I 2.0	10040169-01	40169 5	blaze red	shiny	260	M	52 - 57
Youn-I 2.0	10091888-01	91888 9	rose gold	matt	240	S	48 - 54
Youn-I 2.0	10091889-01	91889 6	rose gold	matt	260	M	52 - 57
Youn-I 2.0	10091885-01	91885 8	midnight blue	matt	240	S	48 - 54
Youn-I 2.0	10091887-01	91887 2	midnight blue	matt	260	M	52 - 57
Youn-I 2.0	10091892-01	91892 6	iced mint	matt	240	S	48 - 54
Youn-I 2.0	10091893-01	91893 3	iced mint	matt	260	M	52 - 57
Spare light URBAN-I 3.0/ HYBAN 2.0/YOUN-I 2.0	10088781-01	88781 9	black			universal	
ABUS Bag	10078592-01	78592 4	black			universal	



# YOUN-I MIPS

## VIEWS



velvet black



velvet black



## TECHNOLOGY



## VERSIONS



Mips

sparkling green



Mips

polar matt

Ref. No.	Art. No.	EAN 4003318	Colour	Finish	Weight g	Size	Head size cm
Youn-I MIPS	10038811-01	38811 8	velvet black	matt	260	S	48 - 54
Youn-I MIPS	10038812-01	38812 5	velvet black	matt	280	M	52 - 57
Youn-I MIPS	10038813-01	38813 2	sparkling green	shiny	260	S	48 - 54
Youn-I MIPS	10038814-01	38814 9	sparkling green	shiny	280	M	52 - 57
Youn-I MIPS	10038809-01	38809 5	polar matt	matt	260	S	48 - 54
Youn-I MIPS	10038810-01	38810 1	polar matt	matt	280	M	52 - 57
Rain Cap Toplight	10039849-01	39849 0	black			universal	
ABUS Bag	10078592-01	78592 4	black			universal	



# SKURB KID

## VIEWS



green jungle



green jungle



## TECHNOLOGY



## VERSIONS



blue sailor



rose foxes



shiny pink



shiny green



shiny red



midnight blue



goldfish orange



shiny black



cream summer



white crowns



grey stars

Ref. No.	Art. No.	EAN 4003318	Colour	Finish	Weight g	Size	Head size cm
Skurb Kid	10004772-01	04772 5	green jungle	shiny	240	S	45 - 50
Skurb Kid	10004774-01	04774 9	green jungle	shiny	250	M	50 - 55
Skurb Kid	10097846-01	97846 3	blue sailor	shiny	240	S	45 - 50
Skurb Kid	10097847-01	97847 0	blue sailor	shiny	250	M	50 - 55
Skurb Kid	10097848-01	97848 7	rose foxes	shiny	240	S	45 - 50
Skurb Kid	10097849-01	97849 4	rose foxes	shiny	250	M	50 - 55
Skurb Kid	10004452-01	04452 6	shiny pink	shiny	240	S	45 - 50
Skurb Kid	10004650-01	04650 6	shiny pink	shiny	250	M	50 - 55
Skurb Kid	10004428-01	04428 1	shiny green	shiny	240	S	45 - 50
Skurb Kid	10004440-01	04440 3	shiny green	shiny	250	M	50 - 55
Skurb Kid	10004300-01	04300 0	shiny red	shiny	240	S	45 - 50
Skurb Kid	10004426-01	04426 7	shiny red	shiny	250	M	50 - 55
Skurb Kid	10004283-01	04283 6	midnight blue	shiny	240	S	45 - 50
Skurb Kid	10004289-01	04289 8	midnight blue	shiny	250	M	50 - 55
Skurb Kid	10004677-01	04677 3	goldfish orange	shiny	240	S	45 - 50
Skurb Kid	10004678-01	04678 0	goldfish orange	shiny	250	M	50 - 55
Skurb Kid	10004296-01	04296 6	shiny black	shiny	240	S	45 - 50
Skurb Kid	10004298-01	04298 0	shiny black	shiny	250	M	50 - 55
Skurb Kid	10004679-01	04679 7	cream summer	shiny	240	S	45 - 50
Skurb Kid	10004680-01	04680 3	cream summer	shiny	250	M	50 - 55
Skurb Kid	10004681-01	04681 0	white crowns	shiny	240	S	45 - 50
Skurb Kid	10004718-01	04718 3	white crowns	shiny	250	M	50 - 55
Skurb Kid	10004744-01	04744 2	grey stars	shiny	240	S	45 - 50
Skurb Kid	10004746-01	04746 6	grey stars	shiny	250	M	50 - 55
Spare light ACE SMILEY 3.0/SKURB KID	10069445-01	69445 5	black			universal	
Spare light SMILEY 3.0/SKURB KID	10091108-01	91108 8	black			universal	
Winter Kit KIDS	10048874-01	48874 0	black			S	
Winter Kit KIDS	10048875-01	48875 7	black			M	
ABUS Bag	10078592-01	78592 4	black			universal	

# SMILEY 3.0 ACE LED

## VIEWS



pure rose



pure rose



## TECHNOLOGY



## VERSIONS



pure mint



pure lavender



pure aqua



royal purple



royal blue



velvet black

Ref. No.	Art. No.	EAN 4003318	Colour	Finish	Weight g	Size	Head size cm
Smiley 3.0 ACE LED	10040345-01	40345 3	pure rose	matt + shiny	230	S	45 - 50
Smiley 3.0 ACE LED	10038030-01	38030 3	pure rose	matt + shiny	250	M	50 - 55
Smiley 3.0 ACE LED	10040344-01	40344 6	pure mint	matt + shiny	230	S	45 - 50
Smiley 3.0 ACE LED	10038029-01	38029 7	pure mint	matt + shiny	250	M	50 - 55
Smiley 3.0 ACE LED	10094291-01	94291 4	pure lavender	matt + shiny	230	S	45 - 50
Smiley 3.0 ACE LED	10040915-01	40915 8	pure lavender	matt + shiny	250	M	50 - 55
Smiley 3.0 ACE LED	10094292-01	94292 1	pure aqua	matt + shiny	230	S	45 - 50
Smiley 3.0 ACE LED	10040916-01	40916 5	pure aqua	matt + shiny	250	M	50 - 55
Smiley 3.0 ACE LED	10067712-01	67712 0	royal purple	shiny	230	S	45 - 50
Smiley 3.0 ACE LED	10067713-01	67713 7	royal purple	shiny	250	M	50 - 55
Smiley 3.0 ACE LED	10067708-01	67708 3	royal blue	shiny	230	S	45 - 50
Smiley 3.0 ACE LED	10067709-01	67709 0	royal blue	shiny	250	M	50 - 55
Smiley 3.0 ACE LED	10066228-01	66228 7	velvet black	matt	230	S	45 - 50
Smiley 3.0 ACE LED	10066239-01	66239 3	velvet black	matt	250	M	50 - 55
Winter Kit KIDS	10048874-01	48874 0	black			S	
Winter Kit KIDS	10048875-01	48875 7	black			M	
ABUS Bag	10078592-01	78592 4	black			universal	



# SMILEY 3.0 LED

## VIEWS



blue car



blue car



## TECHNOLOGY



## VERSIONS



rose strawberry



grey space



blue rainbow

Ref. No.	Art. No.	EAN 4003318	Colour	Finish	Weight g	Size	Head size cm
Smiley 3.0 LED	10067296-01	67296 5	blue car	shiny	230	S	45 - 50
Smiley 3.0 LED	10067297-01	67297 2	blue car	shiny	250	M	50 - 55
Smiley 3.0 LED	10067706-01	67706 9	rose strawberry	shiny	230	S	45 - 50
Smiley 3.0 LED	10067707-01	67707 6	rose strawberry	shiny	250	M	50 - 55
Smiley 3.0 LED	10067298-01	67298 9	grey space	shiny	230	S	45 - 50
Smiley 3.0 LED	10067299-01	67299 6	grey space	shiny	250	M	50 - 55
Smiley 3.0 LED	10067300-01	67300 9	blue rainbow	shiny	230	S	45 - 50
Smiley 3.0 LED	10067301-01	67301 6	blue rainbow	shiny	250	M	50 - 55
Spare light ACE SMILEY 3.0/SKURB KID	10069445-01	69445 5	black			universal	
Winter Kit KIDS	10048874-01	48874 0	black			S	
Winter Kit KIDS	10048875-01	48875 7	black			M	
ABUS Bag	10078592-01	78592 4	black			universal	



# SMILEY 3.0

## VIEWS



pink butterfly



pink butterfly



## TECHNOLOGY



## VERSIONS



shiny yellow



shiny red



shiny pink



shiny orange



shiny green



shiny blue



rose princess



purple star



orange monster



grey police



grey horse



green robo



green nordic



blue whale



blue croco

Ref. No.	Art. No.	EAN 4003318	Colour	Finish	Weight g	Size	Head size cm
Smiley 3.0	10067257-01	67257 6	pink butterfly	shiny	220	S	45 - 50
Smiley 3.0	10067258-01	67258 3	pink butterfly	shiny	240	M	50 - 55
Smiley 3.0	10067277-01	67277 4	shiny yellow	shiny	220	S	45 - 50
Smiley 3.0	10067278-01	67278 1	shiny yellow	shiny	240	M	50 - 55
Smiley 3.0	10067273-01	67273 6	shiny red	shiny	220	S	45 - 50
Smiley 3.0	10067274-01	67274 3	shiny red	shiny	240	M	50 - 55
Smiley 3.0	10067271-01	67271 2	shiny pink	shiny	220	S	45 - 50
Smiley 3.0	10067272-01	67272 9	shiny pink	shiny	240	M	50 - 55
Smiley 3.0	10067275-01	67275 0	shiny orange	shiny	220	S	45 - 50
Smiley 3.0	10067276-01	67276 7	shiny orange	shiny	240	M	50 - 55
Smiley 3.0	10067279-01	67279 8	shiny green	shiny	220	S	45 - 50
Smiley 3.0	10067280-01	67280 4	shiny green	shiny	240	M	50 - 55
Smiley 3.0	10067294-01	67294 1	shiny blue	shiny	220	S	45 - 50
Smiley 3.0	10067295-01	67295 8	shiny blue	shiny	240	M	50 - 55
Smiley 3.0	10067250-01	67250 7	rose princess	shiny	220	S	45 - 50
Smiley 3.0	10067251-01	67251 4	rose princess	shiny	240	M	50 - 55
Smiley 3.0	10067259-01	67259 0	purple star	shiny	220	S	45 - 50
Smiley 3.0	10067260-01	67260 6	purple star	shiny	240	M	50 - 55
Smiley 3.0	10067265-01	67265 1	orange monster	shiny	220	S	45 - 50
Smiley 3.0	10067266-01	67266 8	orange monster	shiny	240	M	50 - 55
Smiley 3.0	10067269-01	67269 9	grey police	shiny	220	S	45 - 50
Smiley 3.0	10067270-01	67270 5	grey police	shiny	240	M	50 - 55
Smiley 3.0	10067252-01	67252 1	grey horse	shiny	220	S	45 - 50
Smiley 3.0	10067253-01	67253 8	grey horse	shiny	240	M	50 - 55
Smiley 3.0	10067267-01	67267 5	green robo	shiny	220	S	45 - 50
Smiley 3.0	10067268-01	67268 2	green robo	shiny	240	M	50 - 55
Smiley 3.0	10067255-01	67255 2	green nordic	shiny	220	S	45 - 50
Smiley 3.0	10067256-01	67256 9	green nordic	shiny	240	M	50 - 55
Smiley 3.0	10067261-01	67261 3	blue whale	shiny	220	S	45 - 50
Smiley 3.0	10067262-01	67262 0	blue whale	shiny	240	M	50 - 55
Smiley 3.0	10067263-01	67263 7	blue croco	shiny	220	S	45 - 50
Smiley 3.0	10067264-01	67264 4	blue croco	shiny	240	M	50 - 55
Spare light ACE SMILEY 3.0/SKURB KID	10069445-01	69445 5	black			universal	
Spare light SMILEY 3.0/SKURB KID	10091108-01	91108 8	black			universal	
Winter Kit KIDS	10048874-01	48874 0	black			S	
Winter Kit KIDS	10048875-01	48875 7	black			M	
ABUS Bag	10078592-01	78592 4	black			universal	

# SMOOTY 2.0

## VIEWS



blue space



blue space



## TECHNOLOGY



## VERSIONS



white smiley



pink watermelon



purple kisses

Ref. No.	Art. No.	EAN 4003318	Colour	Finish	Weight g	Size	Head size cm
Smooty 2.0	10081623-01	81623 9	blue space	shiny	200	S	45 - 50
Smooty 2.0	10081851-01	81851 6	blue space	shiny	220	M	50 - 55
Smooty 2.0	10081852-01	81852 3	white smiley	shiny	200	S	45 - 50
Smooty 2.0	10081853-01	81853 0	white smiley	shiny	220	M	50 - 55
Smooty 2.0	10081854-01	81854 7	pink watermelon	shiny	200	S	45 - 50
Smooty 2.0	10081855-01	81855 4	pink watermelon	shiny	220	M	50 - 55
Smooty 2.0	10081856-01	81856 1	purple kisses	shiny	200	S	45 - 50
Smooty 2.0	10081857-01	81857 8	purple kisses	shiny	220	M	50 - 55
ABUS Bag	10078592-01	78592 4	black			universal	



**HELMET ACCESSORIES**



**REMOTE CONTROL BRAKE LIGHT (HYP-E)**



Page 262

**MAGNETIC VISOR (HYP-E)**



Page 262

**REMOTE CONTROL INDICATOR LIGHT (HYP-E)**



Page 262

**EAR PADS**



ab Page 263

**WINTERKIT**



Page 263

**RACE CAP**



Page 264

**RAIN CAP**



from Page 264

**VISIER**



from Page 265

**RÜCKLICHT**



from Page 266

**REFLEKTOR STICKERSET**



Page 268

**ABUS BEUTEL**



Page 268

**POLSTERSET**



Page 268

## REMOTE CONTROL BRAKE LIGHT (HYP- E)



### TECHNICAL DATA

- Remote control for controlling the brake light for the ABUS HYP-E helmet model and the HYP-E ACE and HYP-E BL.ACE variants
- Cover for the brake lever on the handlebar
- When the brake lever is pulled, the brake light on the HYP-E is activated by a predefined pressure point
- Additional push button on the brake lever to activate the hazard warning light on the front of the helmet
- Compatible with most common brake levers for urban bikes
- Remote control is permanently ready for operation and is activated via the helmet's radio signal

Ref. No.	Art.-NO.	EAN 4003318	Colour	Size	Box Qty
Remote Control Brake Light	10040429-01	40429 0	black	universal	1

## MAGNETIC VISOR (HYP- E)



clear



smoke



photochromic

### TECHNICAL DATA

- Made from hard-wearing polycarbonate
- Flexibility thanks to Magnetic Hub: visor is not a permanently installed component, but can be flexibly attached, removed and replaced
- Visor for the ABUS HYP-E helmet model and the HYP-E ACE and HYP-E BL.ACE variants
- Optionally available in clear (e.g. at dusk), smoke (e.g. in bright light) or photochromic (automatically adapts to light conditions) variants
- The visor can be attached to the helmet quickly and easily using the patented Magnetic Hub
- Visor design enables clear all-round vision at any head angle

Ref. No.	Art.-NO.	EAN 4003318	Colour	Size	Box Qty
Visor	10040947-01	40947 9	clear	S/M	1
Visor	10094563-01	94563 2	clear	L	1
Visor	10094321-01	94321 8	smoke	S/M	1
Visor	10041168-01	41168 7	smoke	L	1
Visor	10038062-01	38062 4	photochromic	S/M	1
Visor	10038276-01	38276 5	photochromic	L	1

## REMOTE CONTROL INDICATOR LIGHT (HYP- E)



### TECHNICAL DATA

- LEDs on the remote control indicate when flashing is taking place by means of a visual signal
- Remote control for controlling the flashing lights for the ABUS HYP-E helmet model and the HYP-E ACE and HYP-E BL.ACE variants
- For mounting on the handlebar: simply attach to the handlebar using the supplied rubber ring
- Compatible with all standard bicycle handlebars with a diameter between 22.2 and 25.4 mm
- Equipped with arrow keys for direction indication
- Remote control is permanently ready for operation and is activated via the helmet's radio signal

Ref. No.	Art.-NO.	EAN 4003318	Colour	Size	Box Qty
Remote Control Indicator Light	10038061-01	38061 7	black	universal	1

## EAR PADS (HYP- E)



### TECHNICAL DATA

- Ear warmers for the ABUS HYP-E helmet model and the HYP-E ACE and HYP-E BL.ACE variants
- Ear muffs keep your ears warm during outdoor activities on your bike – whether in the cold, winter, rain or wind
- EarPads can be quickly and easily retrofitted to the lower edge of the bike helmet
- Soft, breathable and cushioned pads fit comfortably and snugly on the ear
- Washable at 30 degrees in a laundry bag
- Ear warmers replace a hat and ensure that the bike helmet fits securely
- The fabric structure of the EarPads ensures that ambient noise can be easily heard
- Greater visibility thanks to reflective application on the outside of the EarPads

Ref. No.	Art.-NO.	EAN 4003318	Colour	Size	Box Qty
Ear Pads	10040430-01	40430 6	black	universal	1

## EAR PADS (PEDELEC 2.0)



### TECHNICAL DATA

- Additional warming earmuffs which can be attached to the helmet
- Weatherproof: Ear Pads protect against rain, cold, wind and weather.
- Compatible: Ear pads fit the Pedelec 2.0 and are easy to install retrospectively

Ref. No.	Art.-NO.	EAN 4003318	Colour	Size	Box Qty
Ear Pads	10083482-01	83482 0	black	universal	1

## WINTER KIT



### TECHNICAL DATA

- Flexible and comfortable fleece bonnet with ear protection
- Seam welded for comfortable fit

Ref. No.	Art.-NO.	EAN 4003318	Colour	Size	Box Qty
Winter Kit	10048876-01	48876 4	black	M	1
Winter Kit	10048877-01	48877 1	black	L	1
Winter Kit Kids	10048874-01	48874 0	black	S	1
Winter Kit Kids	10048875-01	48875 7	black	M	1

## RACE CAP



autumn black



porto blue



italian white



adventure blue

### TECHNICAL DATA

- 100% Made in Italy
- Large antibacterial sweatband (20 mm diameter) sewn into the Race Cap
- Elastic waistband for custom fit
- Quick-drying blended fabric made from 65% polyester and 35% cotton
- Washable at 30 degrees, not suitable for tumble dryer
- 100% polyester mesh panel in the middle
- Size M/L / 56-61 cm
- Stylish racing cap to wear under the road bike helmet serves as protection from sun and sweat

Ref. No.	Art.-NO.	EAN 4003318	Colour	Size	Head size cm	Box Qty
Race Cap	10096047-01	96047 5	autumn black	M/L	56 - 61	1
Race Cap	10096048-01	96048 2	porto blue	M/L	56 - 61	1
Race Cap	10096049-01	96049 9	italian white	M/L	56 - 61	1
Race Cap	10096046-01	96046 8	adventure blue	M/L	56 - 61	1

## RAIN CAP



### TECHNICAL DATA

- Water-repellent material
- Reflective decorative elements
- Elastic band for individual adjustment of the cap to the helmet size
- Universal rain cap in signal yellow colour. Shape optimised for a number of helmets, with visor in particular

Ref. No.	Art.-NO.	EAN 4003318	Colour	Size	Box Qty
Raincap	10052151-01	52151 5	yellow	universal	1
Raincap	10052154-01	52154 6	black	universal	1

## RAIN CAP TOPLIGHT



### TECHNICAL DATA

- Water-repellent material
- Reflective decorative elements
- Elastic band for individual adjustment of the cap to the helmet size
- Rain cap Toplight is optimized for all helmets with a high LED rear light
- Due to the transparent material the LED rear light is clearly visible

Ref. No.	Art.-NO.	EAN 4003318	Colour	Size	Box Qty
Raincap Toplight	10039849-01	39849 0	black	universal	1

## VISIER GAMECHANGER TT 1.1

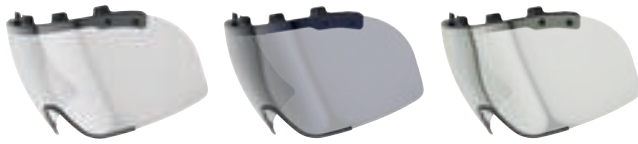

clear

smoke

chrome

### TECHNICAL DATA

- Fog-free visor thanks to good ventilation and therefore always a clear view
- Magnets in the helmet and on the visor frame allow the visor to be held securely and also removed easily
- The large visor allows a clear view to the front, even when the helmet is tilted at a steep angle
- Visor available in three versions
- The visor's form-fit design allows perfect integration with the helmet and offers aerodynamic advantages

Ref. No.	Art.-NO.	EAN 4003318	Colour	Size	Box Qty
Visor	10038199-01	38199 7	clear	S	1
Visor	10094470-01	94470 3	clear	M	1
Visor	10041082-01	41082 6	clear	L	1
Visor	10038200-01	38200 0	smoke	S	1
Visor	10094471-01	94471 0	smoke	M	1
Visor	10041083-01	41083 3	smoke	L	1
Visor	10038198-01	38198 0	chrome	S	1
Visor	10094469-01	94469 7	chrome	M	1
Visor	10041081-01	41081 9	chrome	L	1

## VISIER HYBAN+



clear

smoke

Ref. No.	Art.-NO.	EAN 4003318	Colour	Size	Box Qty
Visor	10076435-01	76435 6	smoke	universal	1
Visor	10076436-01	76436 3	clear	universal	1
Visor Mount	10077325-01	77325 9		universal	1

## VISIER PEDELEC 2.0/HYBAN 2.0/HUD- Y ACE



clear

smoke

Ref. No.	Art.-NO.	EAN 4003318	Colour	Size	Box Qty
Visor	10082888-01	82888 1	smoke	universal	1
Visor	10082889-01	82889 8	clear	universal	1
Visor Mount	10082890-01	82890 4	black	universal	1

## REPLACEMENT LENS BUTEO



### TECHNICAL DATA

- Anti-fog coating
- Available with clear, mirror & tinted lens

Ref. No.	Art.-NO.	EAN 4003318	Colour	Size	Box Qty
Glass Buteo	10068934-01	68934 5	clear	universal	1
Glass Buteo	10068935-01	68935 2	smoke	universal	1
Glass Buteo	10068936-01	68936 9	red chrome	universal	1
Glass Buteo	10068937-01	68937 6	black chrome	universal	1

## REAR LIGHT HUD-Y (ACE)/PURL-Y (ACE)



black

white

### TECHNICAL DATA

- USB rechargeable LED lights for HUD-Y and PURL-Y models
- Intuitive magnetic attachment to the helmet

Ref. No.	Art.-NO.	EAN 4003318	Colour	Size	Box Qty
Rear Light HUD-Y (ACE)/PURL-Y (ACE) PURE	10094421-01	94421 5	white	universal	1
Rear Light HUD-Y (ACE)/PURL-Y (ACE)	10069446-01	69446 2	black	universal	1

## REAR LIGHT SMILEY 3.0/SKURB KID

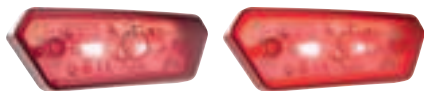

black  
Batterie und USB

white USB

### TECHNICAL DATA

- Optionally with battery or rechargeable spare light (USB) for Smiley 3.0 and Skurb Kid helmet models
- Increases visibility in the dark and at dusk

Ref. No.	Art.-NO.	EAN 4003318	Colour	Size	Box Qty
Rear Light SMILEY 3.0/SKURB KID	10091108-01	91108 8	black	universal	1
Rear Light ACE SMILEY 3.0/SKURB KID	10069445-01	69445 5	black	universal	1
Rear Light ACE SMILEY 3.0/SKURB KID PURE	10041039-01	41039 0	white	universal	1

## REAR LIGHT URBAN-I 4.0/TAIPAN



BASIC

ACE

### TECHNICAL DATA

- Magnetic rear light with USB-C charging port – easily detachable and conveniently rechargeable
- 180° visibility – for improved visibility in darkness, twilight, and bad weather
- Robust and weatherproof (IP44 certified) – protected against dust and water
- Various light modes – to optimally adapt to lighting conditions and battery life
- ACE rear light with premium features – more light modes, two rechargeable batteries for extended runtimes, and powerful LEDs with a diffuser for even, glare-free light distribution

Ref. No.	Art.-NO.	EAN 4003318	Colour	Size	Box Qty
Rear Light URBAN-I 4.0/TAIPAN	10047268-01	47268 8	black	universal	1
Rear Light ACE URBAN-I 4.0/TAIPAN	10047269-01	47269 5	black	universal	1

## REAR LIGHT 2.0 URBAN



### TECHNICAL DATA

- Rechargeable USB light
- Increases visibility in the dark and at dusk

Ref. No.	Art.-NO.	EAN 4003318	Colour	Size	Box Qty
Rear Light 2.0 URBAN	10097625-01	97625 4	black	universal	1

## REAR LIGHT ADURO 3.0



### TECHNICAL DATA

- Rechargeable rear light for attaching to the Aduro 3.0
- 2 modes: continuous and flashing light
- Rubberised button for switching on and off and switching between modes
- IP44 splash-protection
- Micro USB port for charging (charging cable not included) - with rubber cover to protect against moisture and dirt

Ref. No.	Art.-NO.	EAN 4003318	Colour	Size	Box Qty
Rear Light ADURO 3.0	10002939-01	02939 4	black	universal	100

## REFLECTOR STICKER SET



Urban-I 4.0



Urban-I 3.0

### TECHNICAL DATA

- Reflective sticker set for the helmet to improve visibility in the dark and at dusk

Ref. No.	Art.-NO.	EAN 4003318	Colour	Size	Box Qty
Reflector Sticker Set URBAN-I 4.0	10047701-01	47701 0	silver	universal	1
Reflector Sticker Set URBAN-I 3.0	10088782-01	88782 6	silver	universal	1
Reflector Sticker Set HYBAN 2.0	10088783-01	88783 3	silver	universal	1

## ABUS BAG



### TECHNICAL DATA

- Helmet bag with logo print for the protected transport of a bicycle helmet
- Inside pocket is made from protective fleece

Ref. No.	Art.-NO.	EAN 4003318	Colour	Size	Box Qty
ABUS Bag	10078592-01	78592 4	black	universal	1

## PADDING HIDROP



### TECHNICAL DATA

- Fine-tuning the fit: Four optional pad sizes allow for individual customization and adjustment of comfort – even after purchase

Ref. No.	Art.-NO.	EAN 4003318	Colour	Size	Box Qty
Padding HIDROP	10099834-01	99834 8	black	S	1
Padding HIDROP	10099835-01	99835 5	black	M	1
Padding HIDROP	10099836-01	99836 2	black	L	1
Padding HIDROP	10099837-01	99837 9	black	XL	1



# SUCCESSFUL SHOP DESIGN

How you design your shop is a significant part of your economic success from a psychological perspective. We help you in the process of making your showroom a customer-friendly area. By doing so, you do not only ensure successful sales today, but also in the future. Because your customers will always come back.

## 1. STAND OUT

Make your business stand out from the crowd and ensure that your customers feel comfortable in your shop with a warm atmosphere.

## 2. QUALITY WINS

Many years of experience, carefully thought out development processes and high-quality materials are significant for the products themselves as well as for the presentation aids. ABUS has the complete package.

## 3. BE REMEMBERED

Create experiences, that go beyond the simple provision and sale of goods. Touch, try out - go on a discovery tour. This is your advantage especially compared to online businesses.



## WE SUPPORT YOU IN SELLING OUR PRODUCTS

Your needs are very important to us. We support you in the process of creating experiences and transforming the purchase into an event, which you like to think back to - and that you want to repeat.

### MODULAR CONSTRUCTION:

Our new system is designed in such a way that it can be assembled in a modular way from various elements. You can influence the design.



### NUMEROUS ADD-ONS:

Attract attention, help to categorize and inform - combine the tools just the way you need them.



### MODERN DESIGN:

Metal and wood elements combined in an understated „handmade“ look - won't disrupt the existing design of your shop.

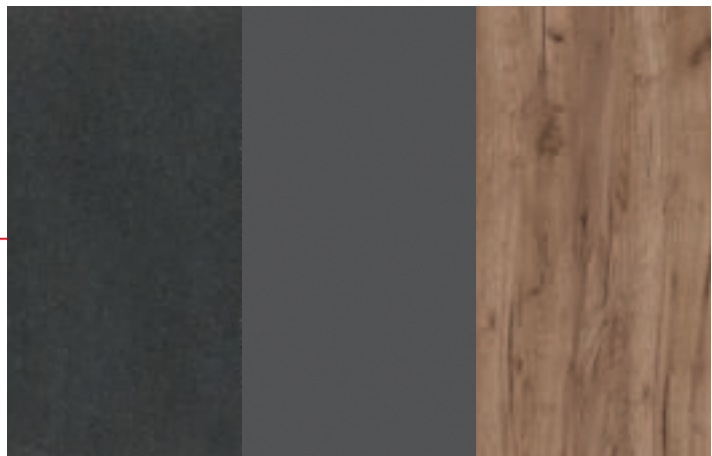

Powder coating  
DB703 micro-  
structure

Graphite Grey  
Kronospan Decor  
0162

Tobacco Craft Oak  
Kronospan Decor  
K004

## WALL DISPLAY

Make full use of height and width of your walls to draw attention to the products. The combination of a solid base and stable back/rear wall ensures a secure stand.



## WALL DISPLAY DIMENSIONS:

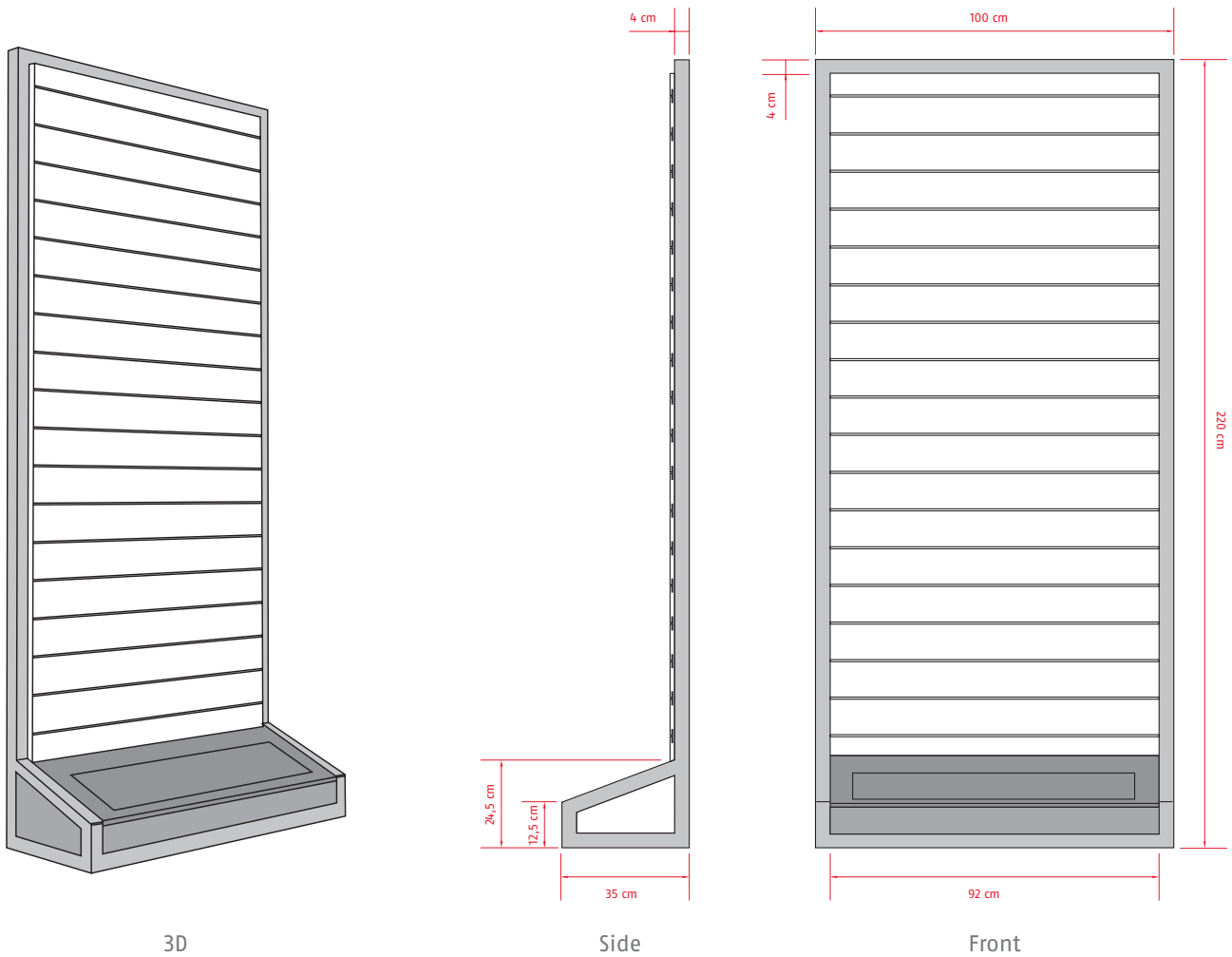

## FEATURES WALL DISPLAY:

Available in 100 cm or 50 cm width, depth 35 cm

Height: 140-260 cm (variable in 40-cm-steps thanks to additional spacers)

Slatwall with option for power supply for lighting etc.



Base in wood look with interchangeable inlays

Optional with removable lid (usable as storage space)

Choose from our range of full-surface, illuminated picture elements

## DIMENSIONS FREE-STANDING DISPLAY:

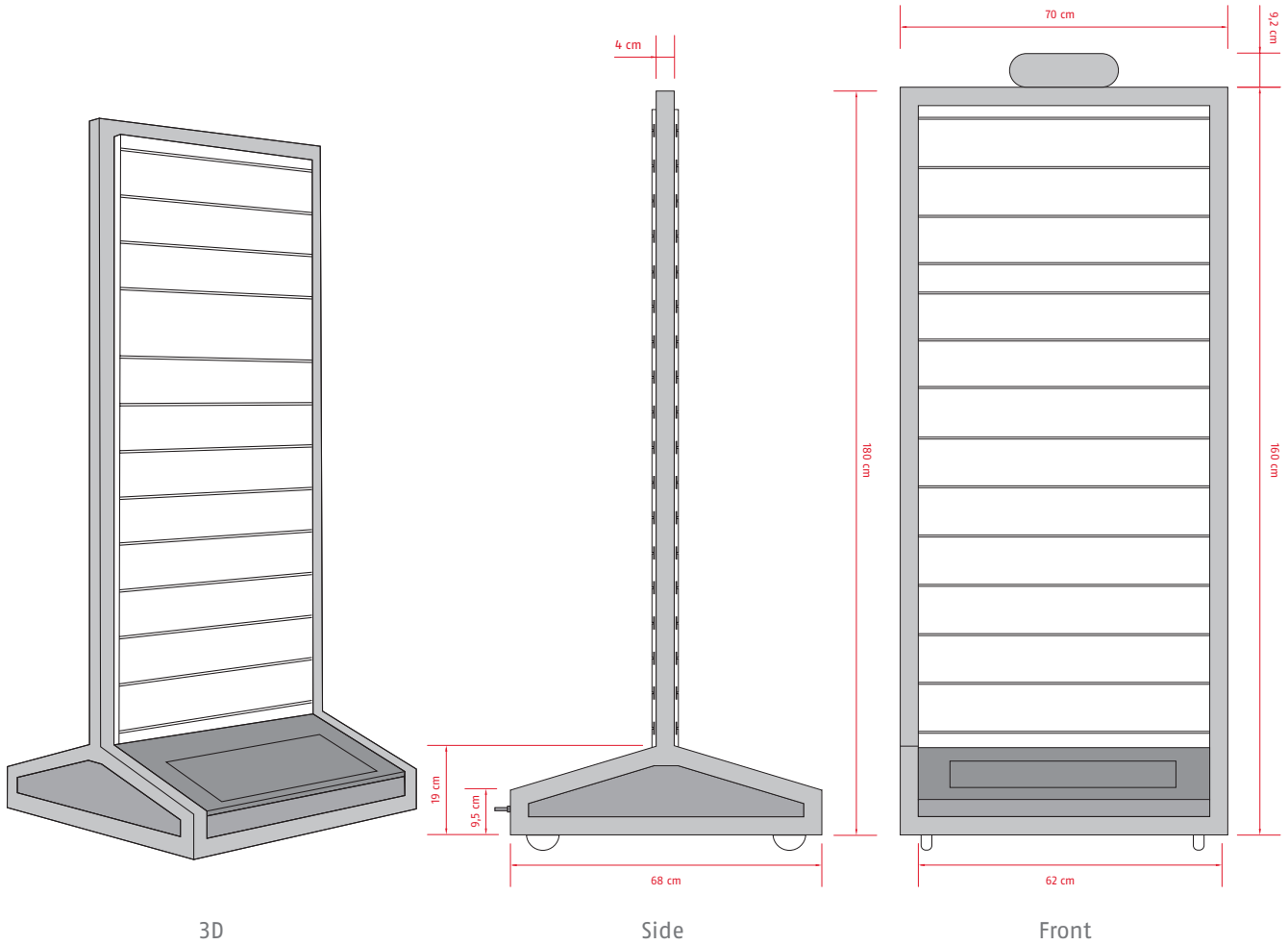

3D

Side

Front

## FREE STANDING DISPLAY

Expand and structure your product categories with free-standing displays - for example for new products or special offers. Thanks to the optional caster wheels you can move the display at any time to a new location.



Both sides can be used for display



Optional & removable cover, can be used for storage



Optional caster wheels make repositioning easy



## BE INSPIRED

Our new product presentation system offers a wide range of possible combinations. You can choose and equip your displays to match your product range and your premises.



Very good balance of merchandising density and matching picture elements

Easy/simple orientation via category signs

Large selection of illuminated picture elements for the tension frames



Inserts with product information as a decision-making aid

Order and clarity thanks to storage space in the base











# INDEX

Ref. No. Locks	Page	Ref. No. Locks	Page	Ref. No. Locks	Page
57 Touch	119	GRANIT CityChain XPlus™ 1060	48	TECTIC™ 496	94
64 TITALIUM™	122	GRANIT XPlus™ 540	18	Tresor 6412C	83
70 & 70IB	123	GRANIT XPlus™ 6950	90	Tresor 6512C	79
145	121	GRANIT™ 460	22	Tresorflex 6615C	75
147TSA	124	GRANIT™ Plus 470	20	Tresor 6806C	61
402	25	GRANIT™ Plus 640	19	Tresor 6807C	60
1200 Web	67	GRANIT™ Super Extreme 2500	16	uGrip BORDO™ 5700C	41
1500 Web	67	GRANIT™ WBA 100	107	uGrip BORDO™ 5700K	40
1850	113	GRANIT™ WBA 75	107	Ultimate 420K	21
3406K	85	INFINITY LOOP 1806	62	Ultra 410K	24
4650S / SL	93	IVEN Chain 8210	52	WA 50	109
4650X / XL	93	IVERA Cable 7220	82	WBA 60	109
4204K Goose Lock	71	IVERA Chain 7210	54	WBA 65	108
6206K Goose Lock	70	IVERA Chain 7210 Color	55	WBA 75 Granit™	107
8808C	53	IVERA Steel-0-Flex™ 7200	74	WBA 100 Granit™	107
ACL ADAPTOR CABLE	97	IVY Chain 9210	49	WCH90	106
ACH ADAPTOR Chain Superior	95	Kette 6KS Loop	112	YARDO 7807F	57
ACH ADAPTOR Chain Classic	96	KeyGarage™ 767	118	Yarnit™ 4004K	58
ACH ADAPTOR Chain Ivytex	97	KeyGarage™ 787	116		
Alarmbox 2.0	105	KeyGarage™ 787 BIG	116		
Alarmbox RC	105	KeyGarage™ 787 BIG LED	116		
Booster 6512K	79	KeyGarage™ 787 LED	116		
BORDO GRANIT™ 6500K	32	KeyGarage™ 787 ONE	115		
BORDO GRANIT™ 6500KA	31	KeyGarage™ 797	117		
BORDO™ 6000C	38	KeyGarage™ 797 LED	117		
BORDO™ 6000C LED	39	KeyGarage™ 797 ONE	115		
BORDO™ 6000K	37	KeyGarage™ 797 Flex	118		
BORDO™ 6000KA	36	Microflex 6615K	75		
BORDO™ 6200K	33	Numerino 5410C	84		
BORDO™ Lite 6055C	43	Numero 5510C	80		
BORDO™ Lite 6055C Mini	43	PHANTOM™ 8950	78		
BORDO™ Lite 6055K	42	Primo 5410K	84		
BORDO™ Lite 6055K Mini	42	Primo 5510K	80		
BORDO™ One 6000A	35	PRO AMPARO 4750 S / SL	92		
BORDO™ One 6000A FINGERPRINT	34	PRO AMPARO 4750 X / XL	91		
BORDO™ One 6500A	30	PRO TECTIC™ 4960	94		
Catena 6806K	63	PS88	114		
Catena 6806K Neon	63	Racer 6412K	83		
Chain Claw 10	104	Sportflex 2504	110		
CityChain™ 1010	50	Star 4508C	81		
Cobra™	113	Star 4508K	81		
Combiflex™	110	Steel-0-Chain™ 4804C	66		
Combiflex™ Adventure	111	Steel-0-Chain™ 4804C SYMBOLS	66		
Combiflex™ Travelguard	111	Steel-0-Chain™ 4804K	65		
Combiloop 205	112	Steel-0-Chain™ 5805C	64		
Diskus® 20	124	Steel-0-Chain™ 5805K	64		
Diskus® 24IB	123	Steel-0-Chain™ 8807K	59		
Everox™ONE 61	119	Steel-0-Chain™ 9808K	51		
Facilo 32	25	Steel-0-Chain™ 9809K	51		
Firestop AFS625	114				

# INDEX

Ref. No.	Page	Ref. No.	Page	Ref. No.	Page
<b>Helmets</b>		<b>Helmets</b>		<b>Helmets</b>	
Basico ST 5200	142	ABUS Bag	268	Smooty 2.0	258 - 259
Bag ST 5850/5650/4960	139	Aduro 3.0	238 - 239	StormChaser ACE	166 - 167
Bracket EaZy KF™	129	Aduro 3.0 LED	236 - 237	Taipan	164 - 165
Bracket GH 50	130	AirBreaker 2.0	154 - 155	Taipan LED	162 - 163
Bracket IVERA RBU	136	AirDrop	180 - 181	Urban-I 4.0	218 - 219
Bracket SH SF Saddlefix	131	Buteo	194 - 195	Urban-I 4.0 ACE	216 - 217
Bracket SCLL	137	Buteo Spare Glass	266	Urban-I 4.0 LR	220 - 221
Bracket SH 5700 uGrip BORDO™	134	CliffHanger	184 - 185	WingBack	172 - 173
Bracket SH 5700 uGrip BORDO™ BIG	134	Earpads (HYP-E)	263	Winter Kit	263
Bracket SH 6000 BORDO™	133	GameChanger 2.0	158 - 159	XOXO	230 - 231
Bracket SH FL BORDO MOUNT	133	GameChanger 2.0 RF	160 - 161	YouDrop FF	244 - 245
Bracket SH 6000 BORDO™ BIG	133	GameChanger TT 1.1	156 - 157	Youn-I 2.0	246 - 247
Bracket SH 6055 BORDO™ Lite	134	GameChanger TT 1.1 accessories visor	265	Youn-I MIPS	248 - 249
Bracket SH 6200K	132	HiDrop	182 - 183		
Bracket SH 6500 BORDO XPlus™	132	HUD-Y	214 - 215		
Bracket SH 6500A ONE	131	HUD-Y ACE	212 - 213		
Bracket SH 6500K BORDO™	132	Hyban 2.0	228 - 229		
Bracket SH B	129	Hyban 2.0 ACE	226 - 227		
Bracket FL	137	Hyban+ accessories visor	265		
Bracket SR 6055 Selle Royal	135	HYP-E	206 - 207		
Bracket Snap Cage	137	HYP-E ACE	204 - 205		
Bracket ST 5700 uGrip BORDO™	136	HYP-E BL.ACE	202 - 203		
Bracket ST 6000 BORDO™	135	Indy	192 - 193		
Bracket ST 6000 BORDO™ BIG	135	Light URBAN	267		
Bracket TexKF Mini	138	Light accessories Smiley 3.0/Skurb	266		
Bracket UGH 02	130	Light Urban-I 4.0/Taipan	267		
Bracket USH 540 / 470 / 460	130	Light accessories USB Aduro 3.0	266		
Bracket USKF	129	Light accessories USB HUD-Y (Ace)/ PURL-Y (Ace)	266		
Chain Bag ST 2012	139	Macator	174 - 175		
FMU 6950	138	Magnetic Visor (HYP-E)	262		
Oryde ST 2085	141	MoDrop	188 - 189		
Oryde ST 2100	142	MoTrip	190 - 191		
Oryde ST 2200	141	Mounting Strap	138		
Oryde ST 2250	141	Moventor 2.0	186 - 187		
Shackle Clamp	131	Pedelec 2.0	210 - 211		
ST 1010	140	Pedelec 2.0 ACE	208 - 209		
ST 5050	140	Pedelec 2.0 Earpads	263		
ST 5950 2.0	142	Pedelec 2.0/Hyban 2.0/HUD-Y ACE Visor	265		
		PowerDome	170 - 171		
		PowerDome ACE	168 - 169		
		PURL-Y	224 - 225		
		PURL-Y ACE	222 - 223		
		Padding Hidrop	268		
		Race Cap	264		
		Rain Cap	264		
		Rain Cap Toplight	264		
		Reflector Stickerset	268		
		Remote Control Brake Light (HYPE-E)	262		
		Remote Control Indicator Light (HYPE-E)	262		
		Skurb	234 - 235		
		Skurb ACE	232 - 233		
		Skurb Kid	250 - 251		
		Smiley 3.0	256 - 257		
		Smiley 3.0 ACE LED	252 - 253		
		Smiley 3.0 LED	254 - 255		





Security Tech Germany



© ABUS | August Bremicker Söhne KG  
[abus.com](http://abus.com)

---

Altenhofer Weg 25  
58300 Wetter | Germany  
[mobilesecurity@abus.de](mailto:mobilesecurity@abus.de)  
+49 2335 - 634 0

Art.-Nr. 10046328-01

KAT MoSi 2026 Gesamt  
GB ohne Preise

